



### General Description

The AFE5Z5VU is an ESD transient voltage suppression component which provides a very high level of protection for sensitive electronic components that may be subjected to electrostatic discharge (ESD). It is particularly well-suited for cellular phones, portable device, digital cameras, power supplies and many other portable applications because of its small package and low weight.

The AFE5Z5VU is Uni-directional, Safely dissipate ESD strikes of Level 4, IEC61000-4-2, exceeding the maximum requirement. Using the MILSTD-883 (Method 3015) specification for Human Body Model (HBM) ESD, the device provides protection for contact discharges to greater than +/-10KV.

The AFE5Z5VU is available in a SOD-523 package with peak reverse working voltage of 5 voltages.

### Features

- Peak Reverse Working Voltage: 5V
- Low leakage current
- High ESD protection Level: >+/-15KV per HBM
- IEC61000-4-2 Level 4 ESD Protection
- IEC61000-4-4 Level 4 EFT Protection

### Pin Description ( SOD-523 )

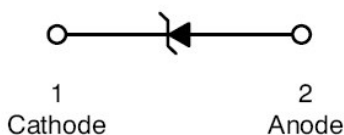

X= Date Code  
x = Specific Device Code

### Application

- Cell phone handsets and accessories
- Personal Digital Assistants (PDAs)
- Notebooks, Desktops, and Servers
- Portable Instrumentation
- Digital Cameras
- MP3/MP4/PMP Players

### Ordering Information

Part Ordering No.	Part Marking	Package	Unit	Quantity
AFE5Z5VUD52RG	Xx	SOD-523	Tape & Reel	3000 EA

- ※ X    Date code
- ※ x    Specific Device Code
- ※ AFE5Z5VUD52RG : 7" Tape & Reel ; Pb- Free ; Halogen- Free



**Absolute Maximum Ratings**

(TA=25°C Unless otherwise noted)

Parameter	Symbol	Typical	Unit
Maximum Peak Pulse Current ( tp = 8/20 μs )	I <sub>PP</sub>	9.0	A
ESD Per IEC 61000– 4 – 2 (Air ) ESD Per IEC 61000 – 4 – 2 (Contact )	V <sub>PP</sub>	±15 ±10	KV
Maximum Lead Temperature for soldering during 10s	T <sub>L</sub>	260	°C
Storage temperature range	T <sub>stg</sub>	-55 ~ +150	°C
Operating temperature range	Top	-55 ~ +150	°C

**Electrical Characteristics**

(TA=25°C Unless otherwise noted)

Parameter	Symbol	Conditions	Min.	Typ	Max.	Unit
Reverse Stand – Off Voltage	V <sub>RWM</sub>				5.0	V
Reverse Breakdown Voltage	V <sub>BR</sub>	I <sub>T</sub> = 1mA	6.2			V
Reverse Leakage Current	I <sub>R</sub>	V <sub>RWM</sub> = 5V			1.0	μA
Clamping Voltage	V <sub>C</sub>	I <sub>PP</sub> = 1A			8.0	V
Junction Capacitance	C			0.5	0.9	pF

**Electronics Parameter**

Symbol	Parameter
V <sub>rw</sub>	Peak Reverse Working Voltage
I <sub>r</sub>	Reverse Leakage Current @ V <sub>rw</sub>
V <sub>br</sub>	Breakdown Voltage @ I <sub>t</sub>
I <sub>t</sub>	Test Current
I <sub>pp</sub>	Maximum Reverse Peak Pulse Current
V <sub>c</sub>	Clamping Voltage @ I <sub>pp</sub>
P <sub>pk</sub>	Peak Power Dissipation
C	Junction Capacitance
I <sub>f</sub>	Forward Current
V <sub>f</sub>	Forward Voltage @ I <sub>f</sub>

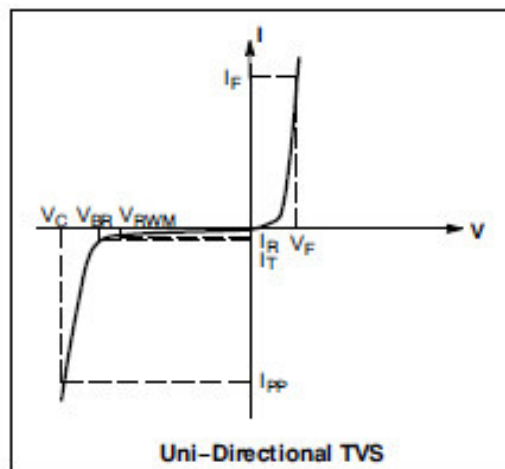



**Typical Characteristics**

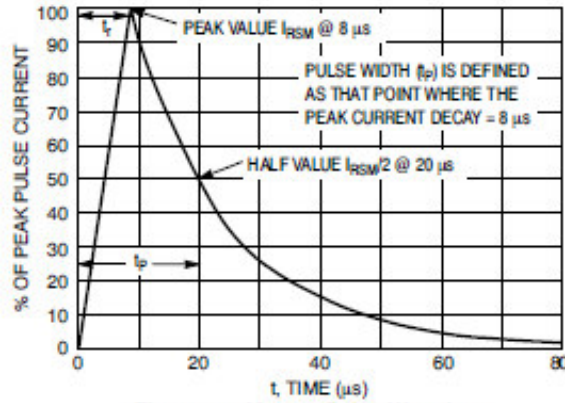

**Figure 1. 8 X 20  $\mu$ s Pulse Waveform**

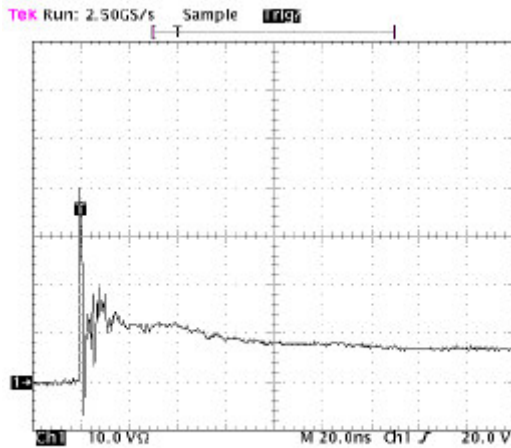

**Figure 2. ESD Clamping Voltage Screenshot  
Positive 8 kV Contact per IEC61000-4-2**

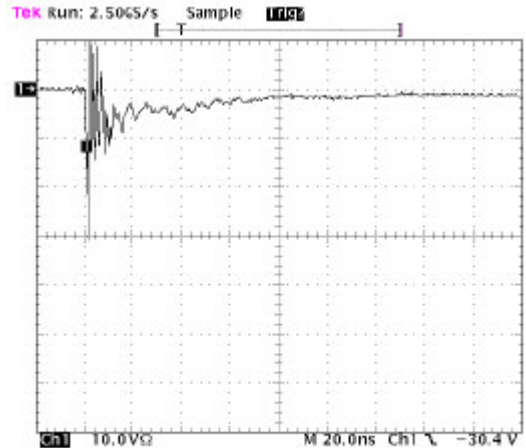

**Figure 3. ESD Clamping Voltage Screenshot  
Negative 8 kV Contact per IEC61000-4-2**

**IEC 61000-4-2 Spec.**

Level	Test Voltage (kV)	First Peak Current (A)	Current at 30 ns (A)	Current at 60 ns (A)
1	2	7.5	4	2
2	4	15	8	4
3	6	22.5	12	6
4	8	30	16	8

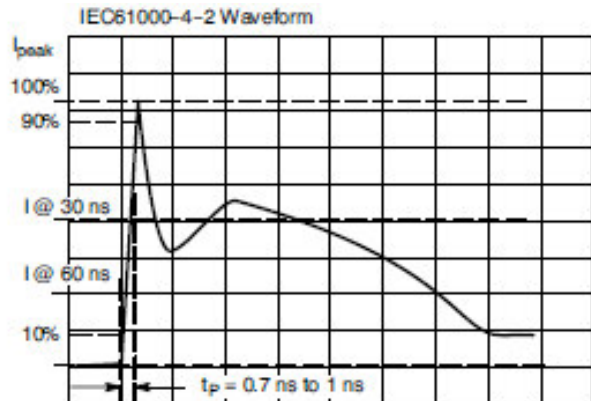

**Figure 4. IEC61000-4-2 Spec**



**Package Information ( SOD-523 )**

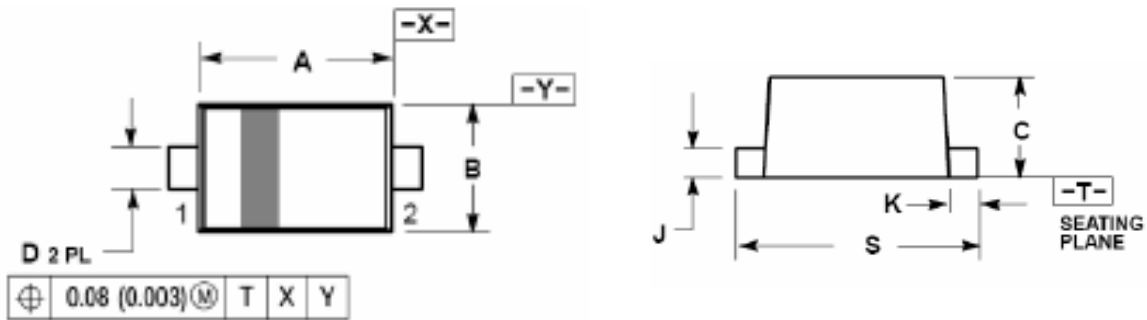

Dim	Millimeters				Inches			
	Min	Nom	Max	Min	Nom	Max	Min	Nom
A	1.10	1.20	1.30	0.043	0.047	0.051	A	1.10
B	0.70	0.80	0.90	0.028	0.032	0.035	B	0.70
C	0.50	0.60	0.70	0.020	0.024	0.028	C	0.50
D	0.25	0.30	0.35	0.010	0.012	0.014	D	0.25
J	0.07	0.14	0.20	0.0028	0.0055	0.0079	J	0.07
K	0.15	0.20	0.25	0.006	0.008	0.010	K	0.15
S	1.50	1.60	1.70	0.059	0.063	0.067	S	1.50

©2010 Alfa-MOS Technology Corp.  
2F, No.80, Sec.1, Cheng Kung Rd., Nan Kang Dist., Taipei City 115, Taiwan (R.O.C.)  
Tel : 886 2) 2651 3928  
Fax : 886 2) 2786 8483  
©http://www.alfa-mos.com