



### General Description

AFN1304, N-Channel enhancement mode MOSFET, uses Advanced Trench Technology to provide excellent  $R_{DS(ON)}$ , low gate charge. These devices are particularly suited for low voltage power management, such as smart phone and notebook computer and other battery powered circuits, and low in-line power loss are needed in commercial industrial surface mount applications.

### Features

- 20V/1.8A,  $R_{DS(ON)}=280m\Omega@V_{GS}=4.5V$
- 20V/1.5A,  $R_{DS(ON)}=340m\Omega@V_{GS}=2.5V$
- 20V/1.2A,  $R_{DS(ON)}=680m\Omega@V_{GS}=1.8V$
- Super high density cell design for extremely low  $R_{DS(ON)}$
- Exceptional on-resistance and maximum DC current capability
- SOT-323 package design

### Pin Description ( SOT-323 )

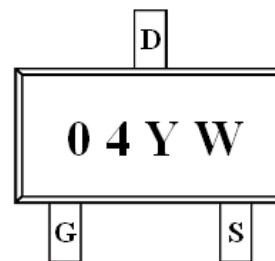
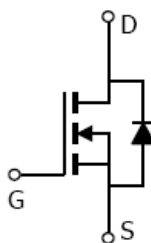
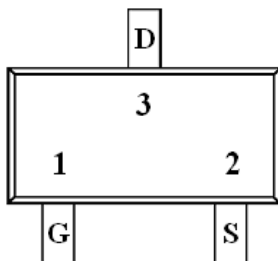

### Application

- Net Working System
- Drivers: Relays, Solenoids, Lamps, Hammers, Displays, Memories
- Battery Operated Systems
- Power Supply Converter Circuits
- Load/Power Switching Smart Phones, Pagers

### Pin Define

Pin	Symbol	Description
1	G	Gate
2	S	Source
3	D	Drain

### Ordering Information

Part Ordering No.	Part Marking	Package	Unit	Quantity
AFN1304S32RG	04YW	SOT-323	Tape & Reel	3000 EA

- ※ 04 parts code
- ※ Y year code ( 0 ~ 9 )
- ※ W week code ( A ~ Z = 1 ~ 26 / a ~ z = 27 ~ 52 )
- ※ AFN1304S32RG : 7" Tape & Reel ; Pb- Free ; Halogen -Free



### Absolute Maximum Ratings

( $T_A=25^\circ\text{C}$  Unless otherwise noted)

Parameter	Symbol	Value	Unit
Drain-Source Voltage	$V_{DSS}$	20	V
Gate-Source Voltage	$V_{GSS}$	$\pm 12$	V
Continuous Drain Current( $T_J=150^\circ\text{C}$ )	$I_D$	$T_A=25^\circ\text{C}$	1.8
		$T_A=70^\circ\text{C}$	1.2
Pulsed Drain Current	$I_{DM}$	6	A
Continuous Source Current(Diode Conduction)	$I_S$	1	A
Power Dissipation	$P_D$	$T_A=25^\circ\text{C}$	0.35
		$T_A=70^\circ\text{C}$	0.22
Operating Junction Temperature	$T_J$	150	$^\circ\text{C}$
Storage Temperature Range	$T_{STG}$	-55/150	$^\circ\text{C}$
Thermal Resistance-Junction to Ambient	$R_{\theta JA}$	120	$^\circ\text{C/W}$

### Electrical Characteristics

( $T_A=25^\circ\text{C}$  Unless otherwise noted)

Parameter	Symbol	Conditions	Min.	Typ	Max.	Unit
<b>Static</b>						
Drain-Source Breakdown Voltage	$V_{(BR)DSS}$	$V_{GS}=0V, I_D=250\mu\text{A}$	20			V
Gate Threshold Voltage	$V_{GS(th)}$	$V_{DS}=V_{GS}, I_D=250\mu\text{A}$	0.4		1.0	
Gate Leakage Current	$I_{GSS}$	$V_{DS}=0V, V_{GS}=\pm 12V$			$\pm 100$	nA
Zero Gate Voltage Drain Current	$I_{DSS}$	$V_{DS}=20V, V_{GS}=0V$			1	uA
		$V_{DS}=20V, V_{GS}=0V$ $T_J=85^\circ\text{C}$			5	
On-State Drain Current	$I_{D(on)}$	$V_{DS} \geq 5V, V_{GS}=4.5V$	1.8			A
Drain-Source On-Resistance	$R_{DS(on)}$	$V_{GS}=4.5V, I_D=1.8A$		240	280	m $\Omega$
		$V_{GS}=2.5V, I_D=1.5A$		300	340	
		$V_{GS}=1.8V, I_D=1.2A$		600	680	
Forward Transconductance	$g_{FS}$	$V_{DS}=10V, I_D=1.0A$		1		S
Diode Forward Voltage	$V_{SD}$	$I_S=1.0A, V_{GS}=0V$		0.65	1.2	V
<b>Dynamic</b>						
Input Capacitance	$C_{iss}$	$V_{DS}=10V, V_{GS}=0V$ $f=1\text{MHz}$		70		pF
Output Capacitance	$C_{oss}$			20		
Reverse Transfer Capacitance	$C_{rss}$			8		
Total Gate Charge	$Q_g$	$V_{DS}=10V, V_{GS}=4.5V$ $I_D \equiv 1.2A$		1.06	1.38	nC
Gate-Source Charge	$Q_{gs}$			0.18		
Gate-Drain Charge	$Q_{gd}$			0.32		
Turn-On Time	$t_{d(on)}$	$V_{DD}=10V, R_L=20\Omega$ $I_D \equiv 1.2A, V_{GEN}=4.5V$ $R_G=1\Omega$		18	26	ns
	$t_r$			20	28	
Turn-Off Time	$t_{d(off)}$			70	110	
	$t_f$			25	40	



## Typical Characteristics

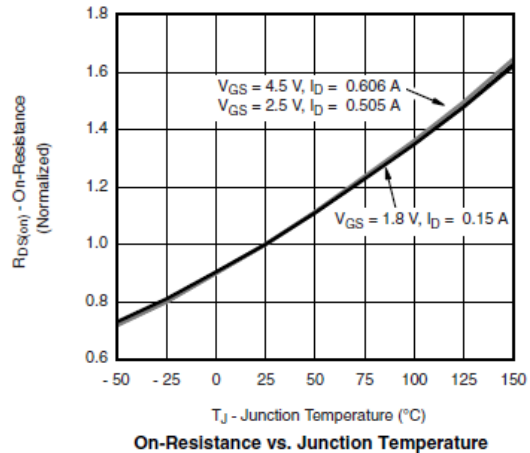
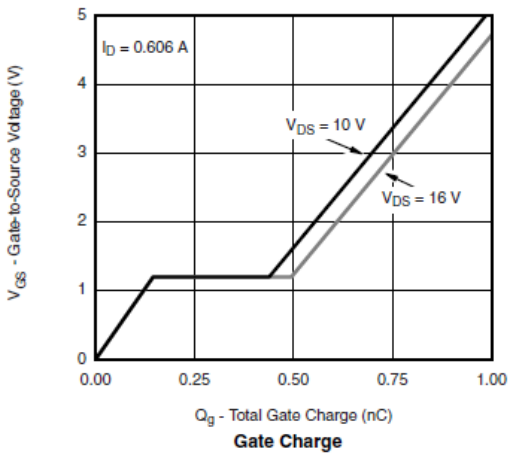
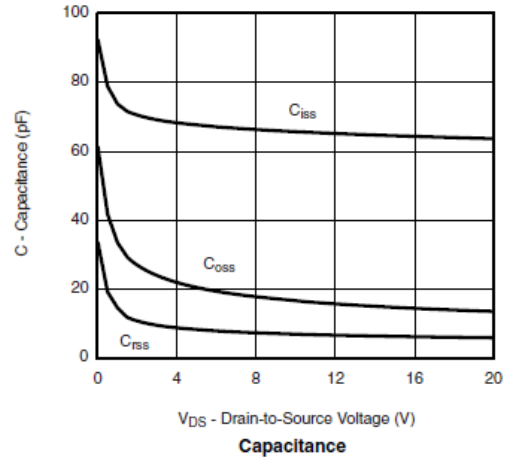
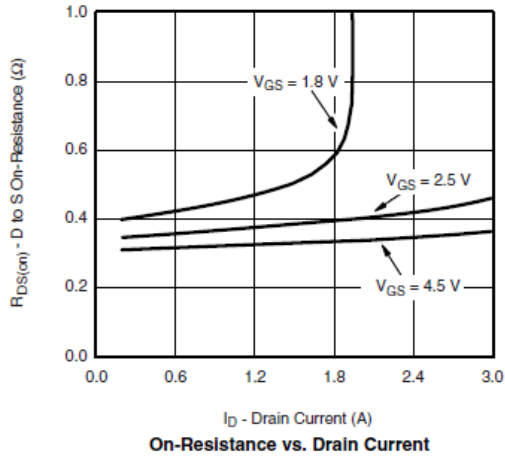
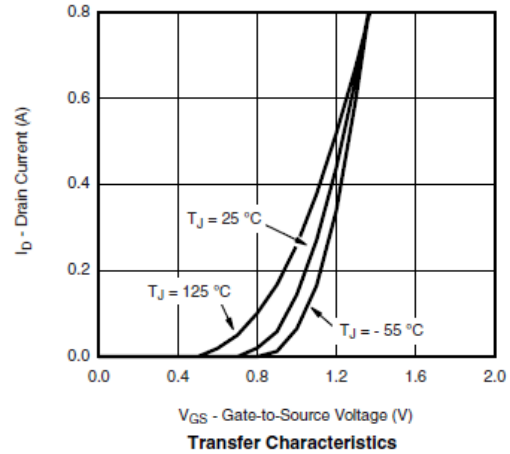
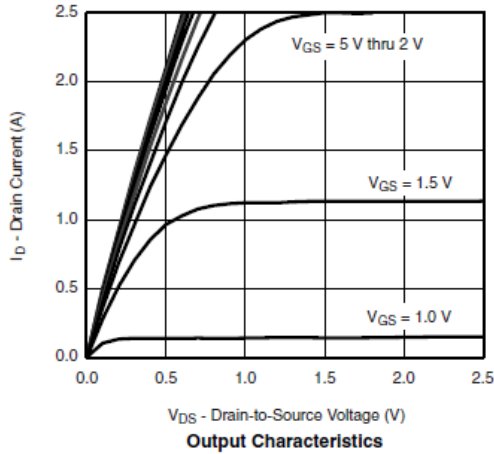



## Typical Characteristics

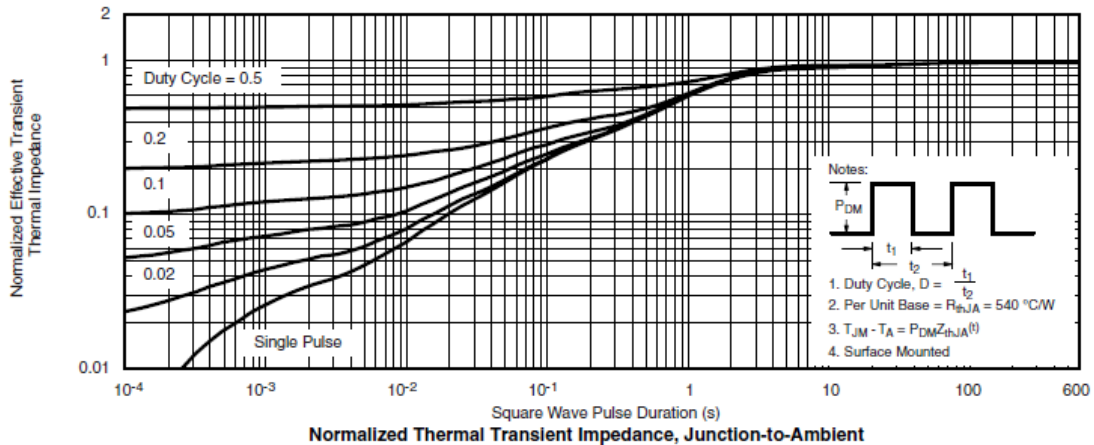
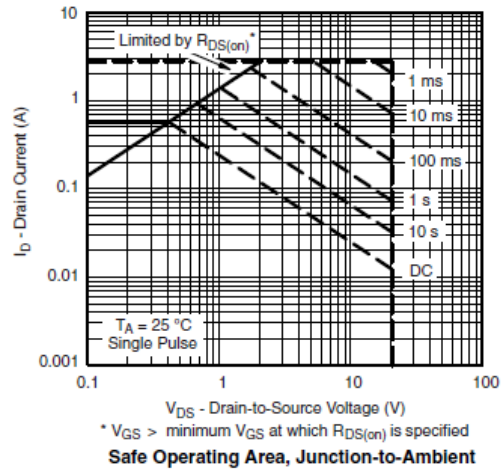
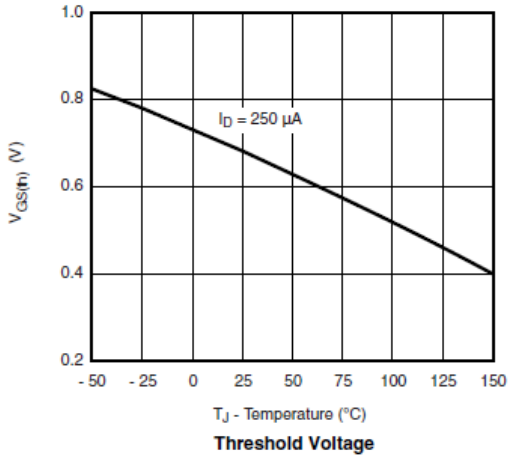
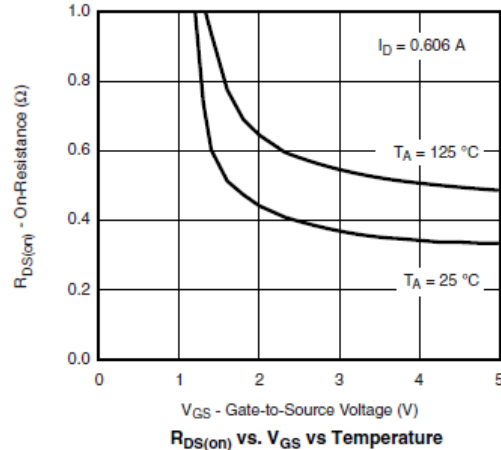
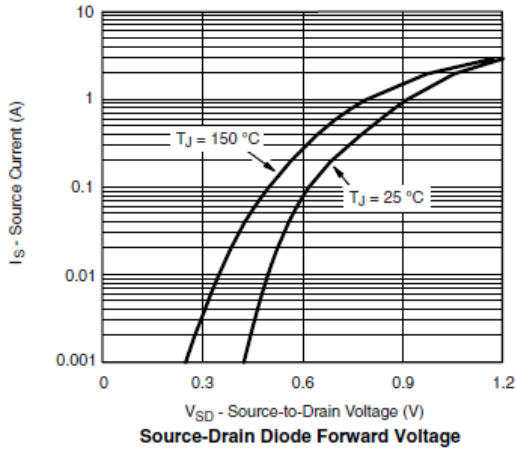



**Typical Characteristics**

Gate Charge Test Circuit & Waveform



Resistive Switching Test Circuit & Waveforms



Unclamped Inductive Switching Test Circuit & Waveforms

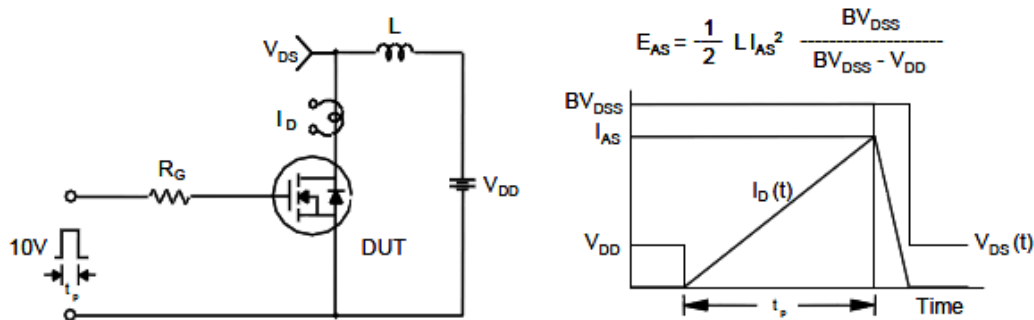



**Package Information ( SOT-323 )**

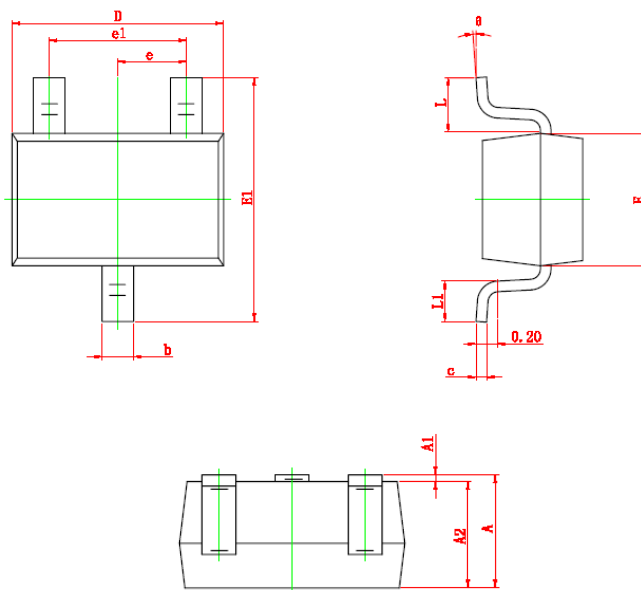

Symbol	Dimensions In Millimeters		Dimensions In Inches	
	Min	Max	Min	Max
A	0.900	1.100	0.035	0.043
A1	0.000	0.100	0.000	0.004
A2	0.900	1.000	0.035	0.039
b	0.200	0.400	0.008	0.016
c	0.080	0.150	0.003	0.006
D	2.000	2.200	0.079	0.087
E	1.150	1.350	0.045	0.053
E1	2.150	2.450	0.085	0.096
e	0.650 TYP		0.026 TYP	
e1	1.200	1.400	0.047	0.055
L	0.525 REF		0.021 REF	
L1	0.260	0.460	0.010	0.018
$\theta$	0°	8°	0°	8°

©2010 Alfa-MOS Technology Corp.  
 2F, No.80, Sec.1, Cheng Kung Rd., Nan Kang Dist., Taipei City 115, Taiwan (R.O.C.)  
 Tel : 886 2) 2651 3928  
 Fax : 886 2) 2786 8483  
 ©http://www.alfa-mos.com