



### General Description

AFN3016S, N-Channel enhancement mode MOSFET, uses Advanced Trench Technology to provide excellent  $R_{DS(ON)}$ , low gate charge. These devices are particularly suited for low voltage power management, and low in-line power loss are needed in commercial industrial surface mount applications.

### Features

- 30V/45A,  $R_{DS(ON)}=6m\Omega@V_{GS}=10V$
- 30V/30A,  $R_{DS(ON)}=9m\Omega@V_{GS}=4.5V$
- Super high density cell design for extremely low  $R_{DS(ON)}$
- TO-252-2L package design

### Pin Description ( TO-252-2L )

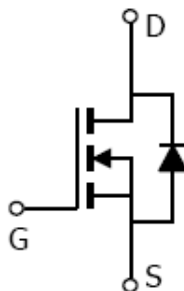
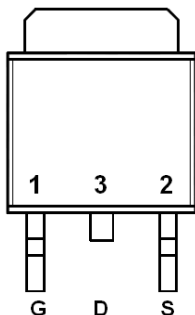

### Application

- Buck Converter
  - High Side
  - Low Side
- Synchronous Rectifier
  - Secondary Rectifier

### Pin Define

Pin	Symbol	Description
1	G	Gate
2	S	Source
3	D	Drain

### Ordering Information

Part Ordering No.	Part Marking	Package	Unit	Quantity
AFN3016ST252RG	3016S	TO-252-2L	Tape & Reel	2500 EA

- ※ A Lot code
- ※ B Date code
- ※ AFN3016ST252RG : 13" Tape & Reel ; Pb- Free ; Halogen -Free



### Absolute Maximum Ratings

( $T_A=25^\circ\text{C}$  Unless otherwise noted)

Parameter	Symbol	Value	Unit
Drain-Source Voltage	$V_{DSS}$	30	V
Gate –Source Voltage	$V_{GSS}$	$\pm 20$	V
Continuous Drain Current( $T_J=150^\circ\text{C}$ )	$I_D$	$T_A=25^\circ\text{C}$	75
		$T_A=70^\circ\text{C}$	55
Pulsed Drain Current	$I_{DM}$	200	A
Continuous Source Current(Diode Conduction)	$I_S$	9.0	A
Power Dissipation	$P_D$	$T_A=25^\circ\text{C}$	40
		$T_A=70^\circ\text{C}$	15
Operating Junction Temperature	$T_J$	150	$^\circ\text{C}$
Storage Temperature Range	$T_{STG}$	-55/150	$^\circ\text{C}$
Thermal Resistance-Junction to Ambient	$R_{\theta JA}$	62.5	$^\circ\text{C/W}$

### Electrical Characteristics

( $T_A=25^\circ\text{C}$  Unless otherwise noted)

Parameter	Symbol	Conditions	Min.	Typ	Max.	Unit
<b>Static</b>						
Drain-Source Breakdown Voltage	$V_{(BR)DSS}$	$V_{GS}=0V, I_D=250\mu\text{A}$	30			V
Gate Threshold Voltage	$V_{GS(th)}$	$V_{DS}=V_{GS}, I_D=250\mu\text{A}$	1.0		2.0	
Gate Leakage Current	$I_{GSS}$	$V_{DS}=0V, V_{GS}=\pm 20V$			$\pm 100$	nA
Zero Gate Voltage Drain Current	$I_{DSS}$	$V_{DS}=24V, V_{GS}=0V$			1	uA
		$V_{DS}=24V, V_{GS}=0V$ $T_J=85^\circ\text{C}$			10	
On-State Drain Current	$I_{D(on)}$	$V_{DS} \geq 5V, V_{GS}=10V$	15			A
Drain-Source On-Resistance	$R_{DS(on)}$	$V_{GS}=10V, I_D=45A$		4.4	6	m $\Omega$
		$V_{GS}=4.5V, I_D=30A$		6.7	9	
Forward Transconductance	$g_{FS}$	$V_{DS}=15V, I_D=10A$		32		S
Diode Forward Voltage	$V_{SD}$	$I_S=30A, V_{GS}=0V$		0.8	1.3	V
<b>Dynamic</b>						
Total Gate Charge	$Q_g$	$V_{DS}=15V, V_{GS}=4.5V$ $I_D \equiv 15A$		10	15	nC
Gate-Source Charge	$Q_{gs}$			3.8		
Gate-Drain Charge	$Q_{gd}$			3.2		
Input Capacitance	$C_{iss}$	$V_{DS}=15V, V_{GS}=0V$ $f=1\text{MHz}$		1350		pF
Output Capacitance	$C_{oss}$			210		
Reverse Transfer Capacitance	$C_{rss}$			95		
Turn-On Time	$t_{d(on)}$	$V_{DD}=15V, R_L=1.5\Omega$ $I_D \equiv 10A, V_{GEN}=10V$ $R_G=1\Omega$		10	15	ns
	$t_r$			10	15	
Turn-Off Time	$t_{d(off)}$			25	35	
	$t_f$			10	15	



## Typical Characteristics

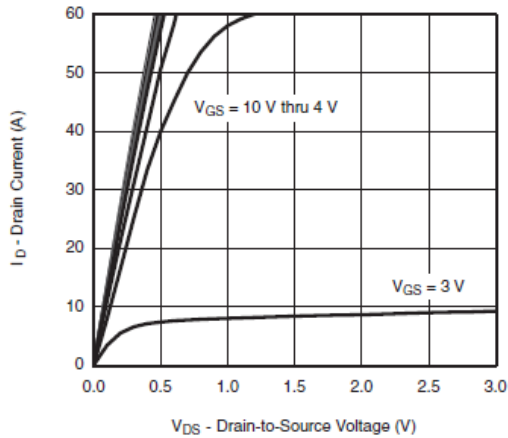

Output Characteristics

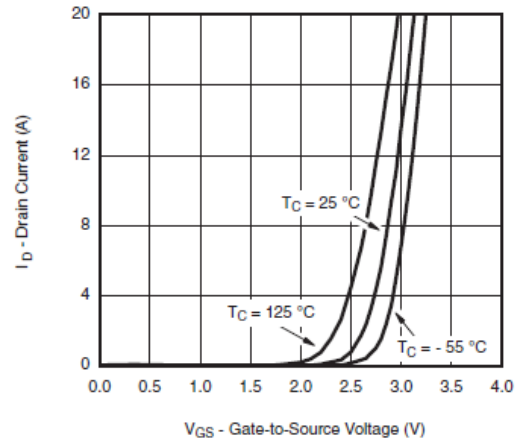

Transfer Characteristics

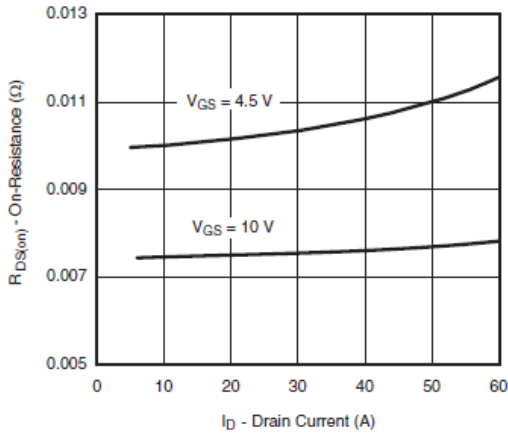

On-Resistance vs. Drain Current

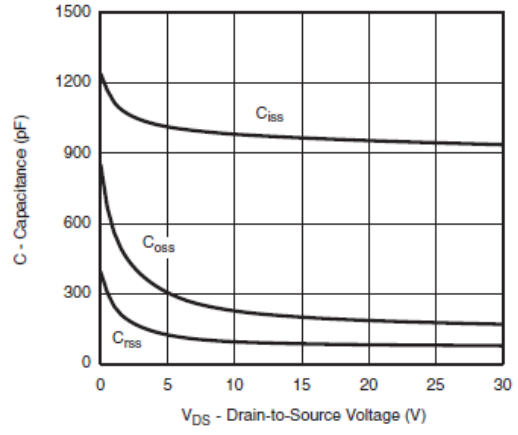

Capacitance

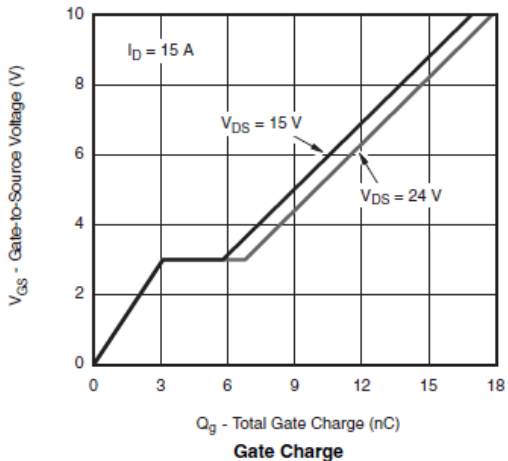

Gate Charge

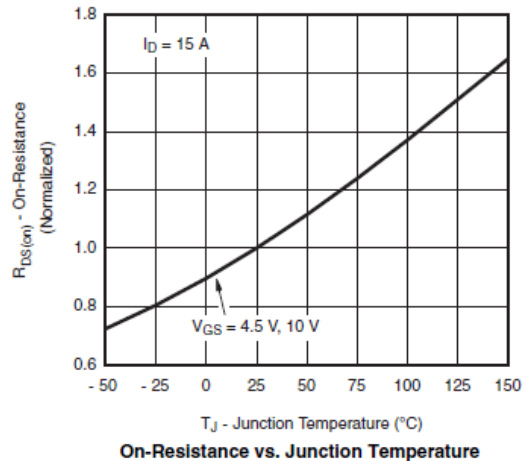

On-Resistance vs. Junction Temperature



## Typical Characteristics

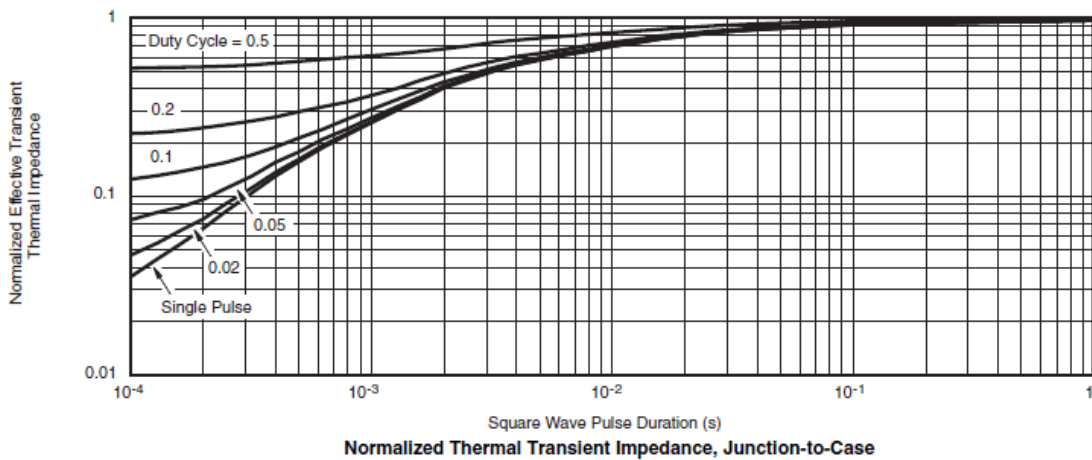
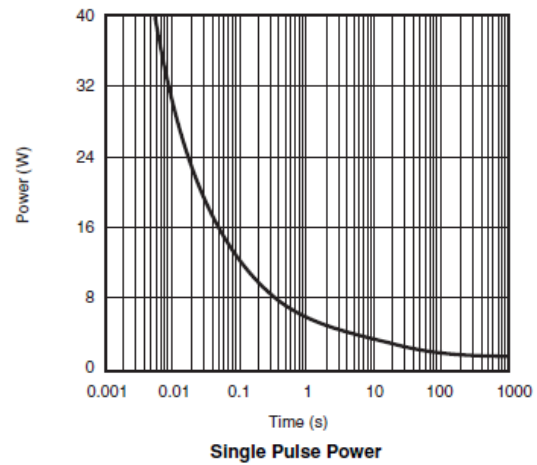
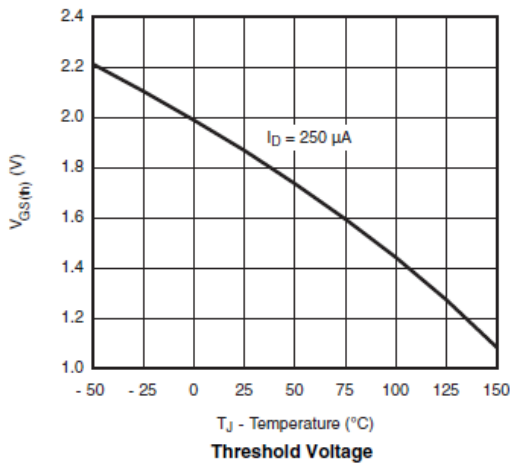
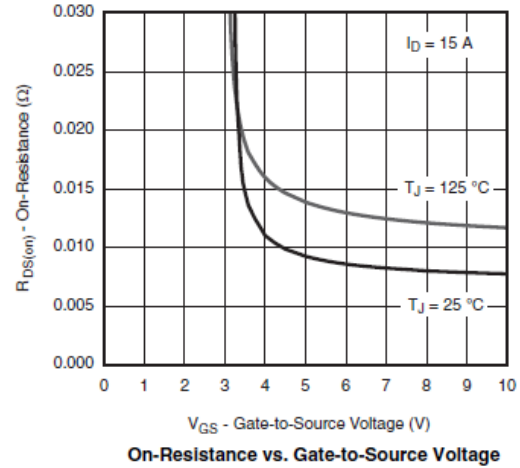
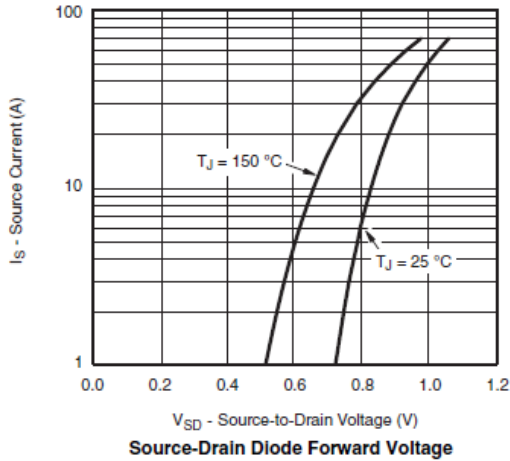



Typical Characteristics

Gate Charge Test Circuit & Waveform



Resistive Switching Test Circuit & Waveforms



Unclamped Inductive Switching Test Circuit & Waveforms

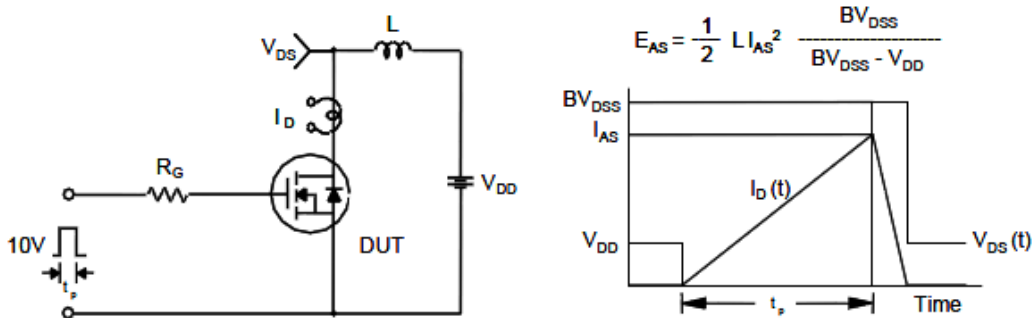



**Package Information ( TO-252-2L )**

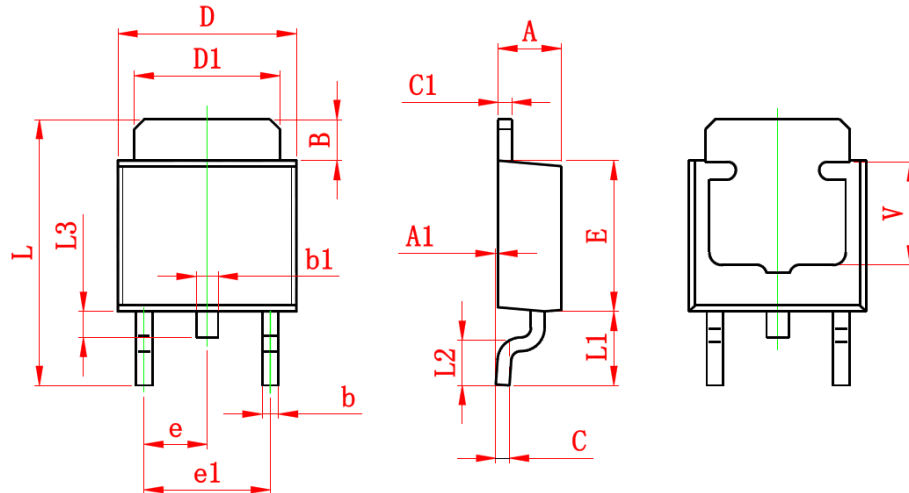

Symbol	Dimensions In Millimeters		Dimensions In Inches	
	Min.	Max.	Min.	Max.
A	2.200	2.400	0.087	0.094
A1	0.000	0.127	0.000	0.005
B	1.350	1.650	0.053	0.065
b	0.500	0.700	0.020	0.028
b1	0.700	0.900	0.028	0.035
c	0.430	0.580	0.017	0.023
c1	0.430	0.580	0.017	0.023
D	6.350	6.650	0.250	0.262
D1	5.200	5.400	0.205	0.213
E	5.400	5.700	0.213	0.224
e	2.300 TYP.		0.091 TYP.	
e1	4.500	4.700	0.177	0.185
L	9.500	9.900	0.374	0.390
L1	2.550	2.900	0.100	0.114
L2	1.400	1.780	0.055	0.070
L3	0.600	0.900	0.024	0.035
V	3.800 REF.		0.150 REF.	

©2010 Alfa-MOS Technology Corp.  
2F, No.80, Sec.1, Cheng Kung Rd., Nan Kang Dist., Taipei City 115, Taiwan (R.O.C.)  
Tel : 886 2) 2651 3928  
Fax : 886 2) 2786 8483  
©http://www.alfa-mos.com