



General Description

AFN3414A, N-Channel enhancement mode MOSFET, uses Advanced Trench Technology to provide excellent $R_{DS(ON)}$, low gate charge.

These devices are particularly suited for low voltage power management, such as smart phone and notebook computer and other battery powered circuits, and low in-line power loss are needed in commercial industrial surface mount applications.

Features

- 20V/2.4A, $R_{DS(ON)}=60m\Omega@V_{GS}=4.5V$
- 20V/2.0A, $R_{DS(ON)}=70m\Omega@V_{GS}=2.5V$
- 20V/1.8A, $R_{DS(ON)}=100m\Omega@V_{GS}=1.8V$
- Super high density cell design for extremely low $R_{DS(ON)}$
- Exceptional on-resistance and maximum DC current capability
- SOT-23 package design

Pin Description (SOT-23)

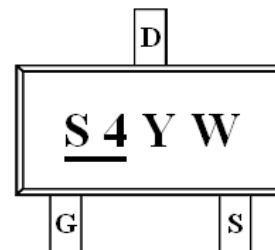
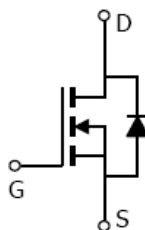
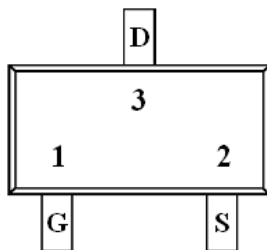

Application

- Portable Equipment
- Battery Powered System
- Net Working System

Pin Define

Pin	Symbol	Description
1	G	Gate
2	S	Source
3	D	Drain

Ordering Information

Part Ordering No.	Part Marking	Package	Unit	Quantity
AFN3414AS23RG	S4YW	SOT-23	Tape & Reel	3000 EA

- ※ S4 parts code
- ※ Y year code (0 ~ 9)
- ※ W week code (A ~ Z = 1 ~ 26 / a ~ z = 27 ~ 52)
- ※ AFN3414AS23RG : 7" Tape & Reel ; Pb- Free ; Halogen -Free



Absolute Maximum Ratings

(T_A=25°C Unless otherwise noted)

Parameter	Symbol	Value	Unit
Drain-Source Voltage	V _{DSS}	20	V
Gate-Source Voltage	V _{GSS}	±12	V
Continuous Drain Current(T _J =150°C)	I _D	T _A =25°C	2.4
		T _A =70°C	2.0
Pulsed Drain Current	I _{DM}	10	A
Continuous Source Current(Diode Conduction)	I _S	1.6	A
Power Dissipation	P _D	T _A =25°C	1.25
		T _A =70°C	0.8
Operating Junction Temperature	T _J	150	°C
Storage Temperature Range	T _{STG}	-55/150	°C
Thermal Resistance-Junction to Ambient	R _{θJA}	120	°C/W

Electrical Characteristics

(T_A=25°C Unless otherwise noted)

Parameter	Symbol	Conditions	Min.	Typ	Max.	Unit
Static						
Drain-Source Breakdown Voltage	V _{(BR)DSS}	V _{GS} =0V, I _D =250μA	20			V
Gate Threshold Voltage	V _{GS(th)}	V _{DS} =V _{GS} , I _D =250μA	0.5		1.0	
Gate Leakage Current	I _{GSS}	V _{DS} =0V, V _{GS} =±12V			±100	nA
Zero Gate Voltage Drain Current	I _{DSS}	V _{DS} =16V, V _{GS} =0V			1	μA
		V _{DS} =16V, V _{GS} =0V T _J =85°C			10	
On-State Drain Current	I _{D(on)}	V _{DS} ≥ 5V, V _{GS} =4.5V	6			A
		V _{DS} ≥ 5V, V _{GS} =2.5V	4			
Drain-Source On-Resistance	R _{DS(on)}	V _{GS} =4.5V, I _D =2.4A		35	60	mΩ
		V _{GS} =2.5V, I _D =2.0A		40	70	
		V _{GS} =1.8V, I _D =1.8A		55	100	
Forward Transconductance	g _{FS}	V _{DS} =5V, I _D =3.6A		10		S
Diode Forward Voltage	V _{SD}	I _S =1.6A, V _{GS} =0V		0.85	1.2	V
Dynamic						
Total Gate Charge	Q _g	V _{DS} =10V, V _{GS} =4.5V I _D ≧3.6A		4.2	5.0	nC
Gate-Source Charge	Q _{gs}			0.6		
Gate-Drain Charge	Q _{gd}			0.4		
Input Capacitance	C _{iss}	V _{DS} =10V, V _{GS} =0V f=1MHz		340		pF
Output Capacitance	C _{oss}			115		
Reverse Transfer Capacitance	C _{rss}			33		
Turn-On Time	t _{d(on)}	V _{DD} =10V, R _L =2.8Ω I _D ≧3.6A, V _{GEN} =4.5V R _G =1Ω		8	15	ns
	t _r			8	15	
Turn-Off Time	t _{d(off)}			25	40	
	t _f			8	15	



Typical Characteristics

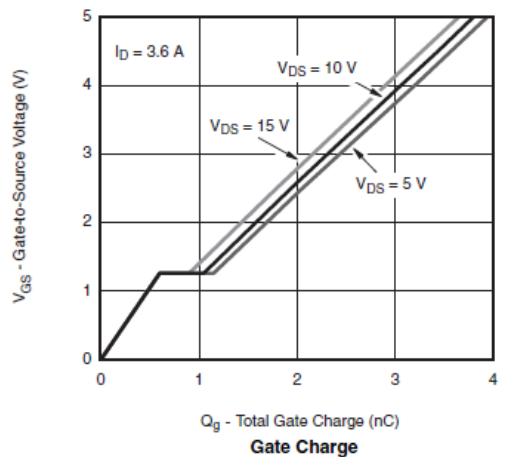
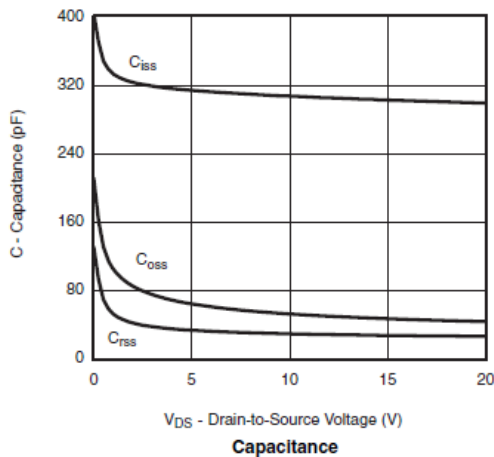
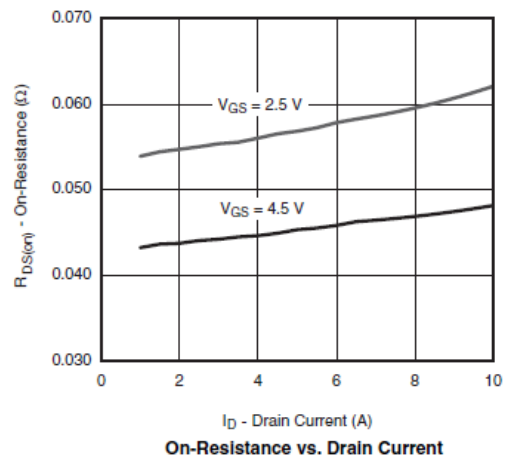
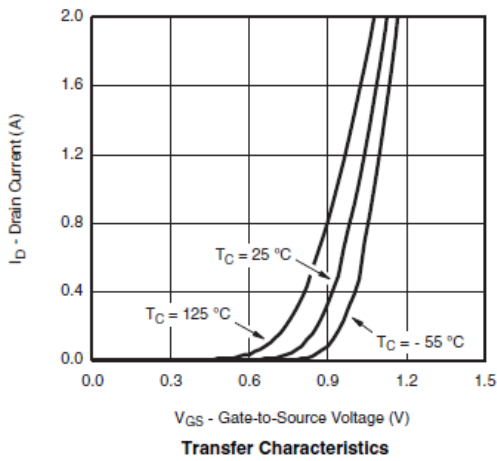
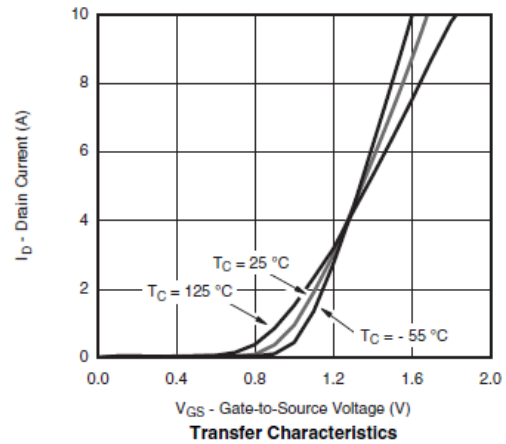
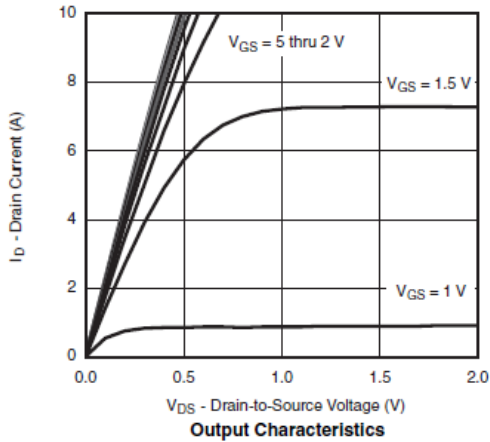



Typical Characteristics

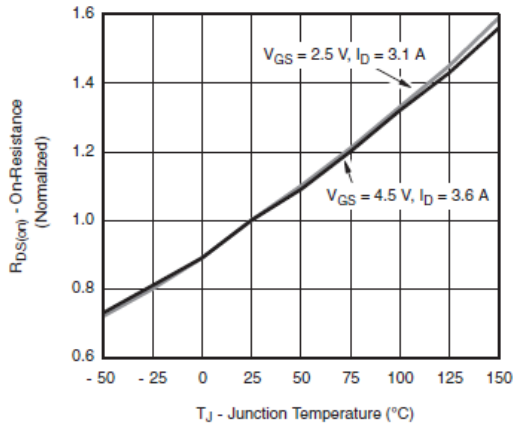

On-Resistance vs. Junction Temperature

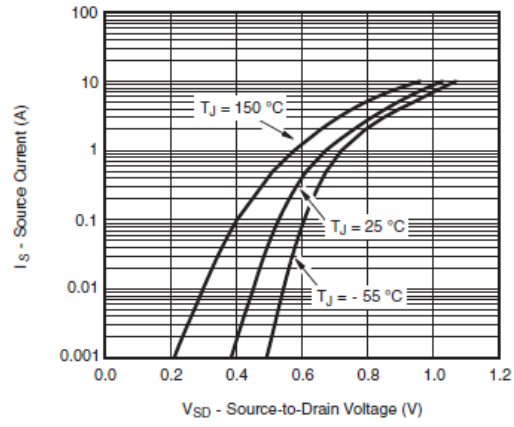

Source-Drain Diode Forward Voltage

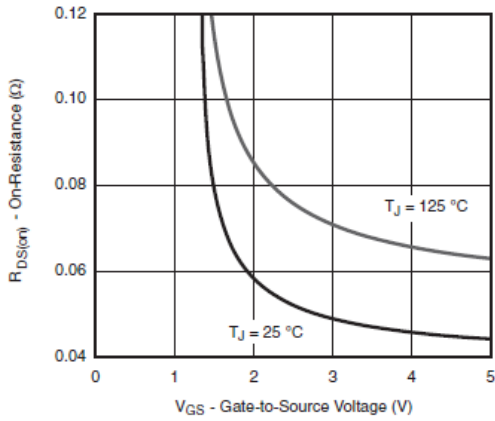

On-Resistance vs. Gate-to-Source Voltage

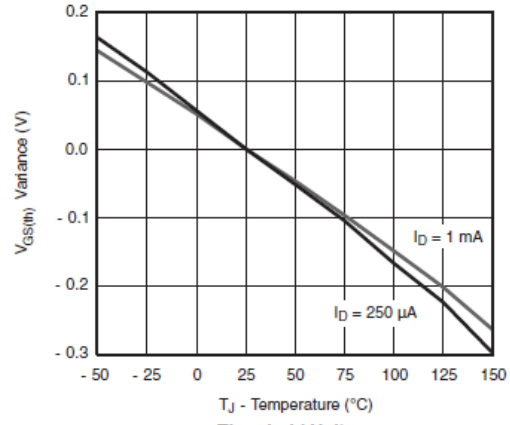

Threshold Voltage

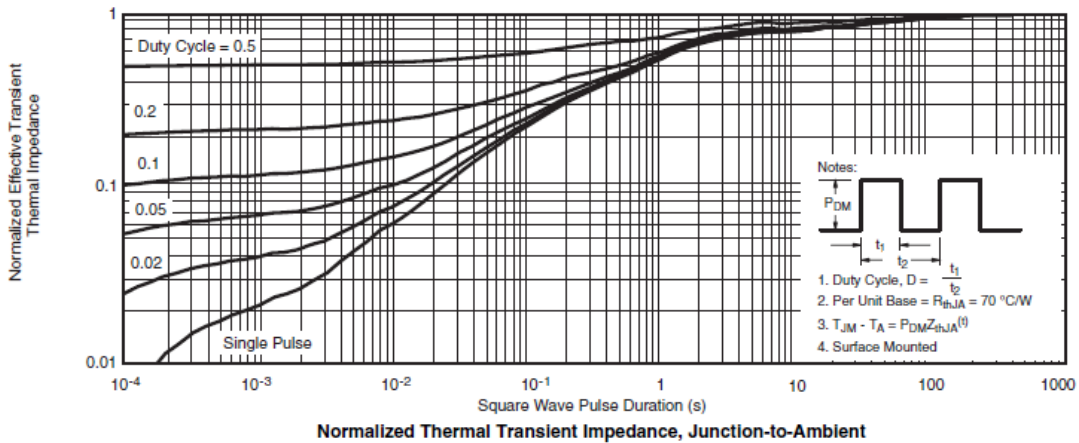

Normalized Thermal Transient Impedance, Junction-to-Ambient



Typical Characteristics

Gate Charge Test Circuit & Waveform



Resistive Switching Test Circuit & Waveforms



Unclamped Inductive Switching Test Circuit & Waveforms





Package Information (SOT-23)

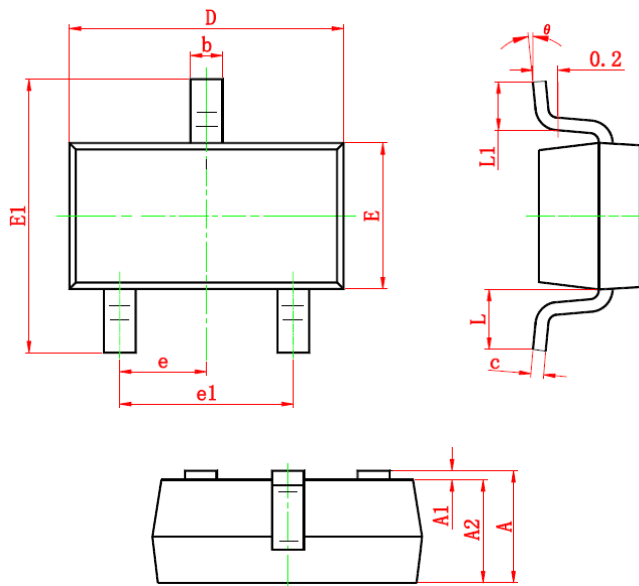

Symbol	Dimensions In Millimeters		Dimensions In Inches	
	Min	Max	Min	Max
A	0.900	1.200	0.035	0.043
A1	0.000	0.100	0.000	0.004
A2	0.900	1.100	0.035	0.039
b	0.300	0.500	0.012	0.020
c	0.080	0.150	0.003	0.006
D	2.800	3.000	0.110	0.118
E	1.200	1.400	0.047	0.055
E1	2.250	2.550	0.089	0.100
e	0.950 TYP		0.037 TYP	
e1	1.800	2.000	0.071	0.079
L	0.550 REF		0.022 REF	
L1	0.300	0.500	0.012	0.020
θ	0°	8°	0°	6°

©2010 Alfa-MOS Technology Corp.
 2F., No.80, Sec. 1, Chenggong Rd., Nangang Dist., Taipei City 115, Taiwan (R.O.C.)
 Tel : 886 2) 2651 3928
 Fax : 886 2) 2786 8483
 ©http://www.alfa-mos.com