



## General Description

AFN3478W, N-Channel enhancement mode MOSFET, uses Advanced Trench Technology to provide excellent  $R_{DS(ON)}$ , low gate charge.

These devices are particularly suited for low voltage power management, such as smart phone and notebook computer and other battery powered circuits, and low in-line power loss are needed in commercial industrial surface mount applications.

## Features

- $I_D=1.5A, R_{DS(ON)}=580m\Omega@V_{GS}=10V$
- $I_D=1.0A, R_{DS(ON)}=600m\Omega@V_{GS}=4.5V$
- Super high density cell design for extremely low  $R_{DS(ON)}$
- Exceptional on-resistance and maximum DC current capability
- SOT-23-6L package design

## Pin Description ( SOT-23-6L )

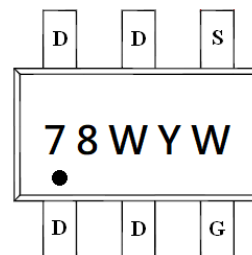
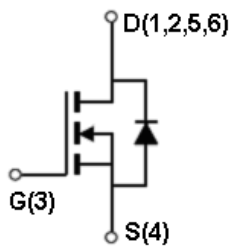
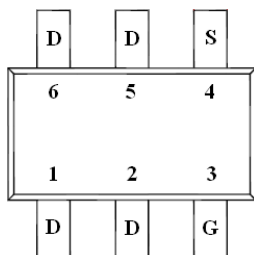

## Application

- DC/DC Converters
- Load Switch
- LED Backlighting in LCD TVs

## Pin Define

Pin	Symbol	Description
1	D	Drain
2	D	Drain
3	G	Gate
4	S	Source
5	D	Drain
6	D	Drain

## Ordering Information

Part Ordering No.	Part Marking	Package	Unit	Quantity
AFN3478WS26RG	78WYW	SOT-23-6L	Tape & Reel	3000 EA

※ 78W parts code

※ Y year code ( 0 ~ 9 )

※ W week code ( A ~ Z = 1 ~ 26 / a ~ z = 27 ~ 52 )

※ AFN3478WS26RG : 7" Tape & Reel ; Pb- Free ; Halogen -Free



### Absolute Maximum Ratings

(T<sub>A</sub>=25°C Unless otherwise noted)

Parameter	Symbol	Typical	Unit
Drain-Source Voltage	V <sub>DSS</sub>	200	V
Gate –Source Voltage	V <sub>GSS</sub>	±20	V
Continuous Drain Current(T <sub>J</sub> =150°C)	I <sub>D</sub>	T <sub>c</sub> =25°C	3.0
		T <sub>c</sub> =70°C	1.5
Pulsed Drain Current	I <sub>DM</sub>	6	A
Continuous Source Current(Diode Conduction)	I <sub>S</sub>	4	A
Power Dissipation	P <sub>D</sub>	T <sub>A</sub> =25°C	2.0
		T <sub>A</sub> =70°C	1.3
Operating Junction Temperature	T <sub>J</sub>	150	°C
Storage Temperature Range	T <sub>STG</sub>	-55/150	°C
Thermal Resistance-Junction to Ambient	R <sub>θJA</sub>	120	°C/W

### Electrical Characteristics

(T<sub>A</sub>=25°C Unless otherwise noted)

Parameter	Symbol	Conditions	Min.	Typ	Max.	Unit
<b>Static</b>						
Drain-Source Breakdown Voltage	V <sub>(BR)DSS</sub>	V <sub>GS</sub> =0V, I <sub>D</sub> =250uA	200			V
Gate Threshold Voltage	V <sub>GS(th)</sub>	V <sub>DS</sub> =V <sub>GS</sub> , I <sub>D</sub> =250uA	1.0		3.0	
Gate Leakage Current	I <sub>GSS</sub>	V <sub>DS</sub> =0V, V <sub>GS</sub> =±20V			±100	nA
Zero Gate Voltage Drain Current	I <sub>DSS</sub>	V <sub>DS</sub> =160V, V <sub>GS</sub> =0V			1	uA
		V <sub>DS</sub> =160V, V <sub>GS</sub> =0V T <sub>J</sub> =85°C			10	
Drain-Source On-Resistance	R <sub>DS(on)</sub>	V <sub>GS</sub> =10V, I <sub>D</sub> =1.5A		500	580	mΩ
		V <sub>GS</sub> =4.5V, I <sub>D</sub> =1.0A		520	600	
Forward Transconductance	g <sub>FS</sub>	V <sub>DS</sub> =10V, I <sub>D</sub> =1.0A		10		S
Diode Forward Voltage	V <sub>SD</sub>	I <sub>S</sub> =1.0A, V <sub>GS</sub> =0V		0.85	1.2	V
<b>Dynamic</b>						
Total Gate Charge	Q <sub>g</sub>	V <sub>DS</sub> =160V, V <sub>GS</sub> =10V I <sub>D</sub> ≧1.0A		15	30	nC
Gate-Source Charge	Q <sub>gs</sub>			3		
Gate-Drain Charge	Q <sub>gd</sub>			6		
Input Capacitance	C <sub>iss</sub>	V <sub>DS</sub> =25V, V <sub>GS</sub> =0V f=1MHz		900		pF
Output Capacitance	C <sub>oss</sub>			130		
Reverse Transfer Capacitance	C <sub>rss</sub>			5		
Turn-On Time	t <sub>d(on)</sub>	V <sub>DD</sub> =100, R <sub>G</sub> =3Ω I <sub>D</sub> ≧1.0A, V <sub>GEN</sub> =10V		25	50	ns
	t <sub>r</sub>			35	70	
Turn-Off Time	t <sub>d(off)</sub>			45	90	
	t <sub>f</sub>			10	20	



## Typical Characteristics

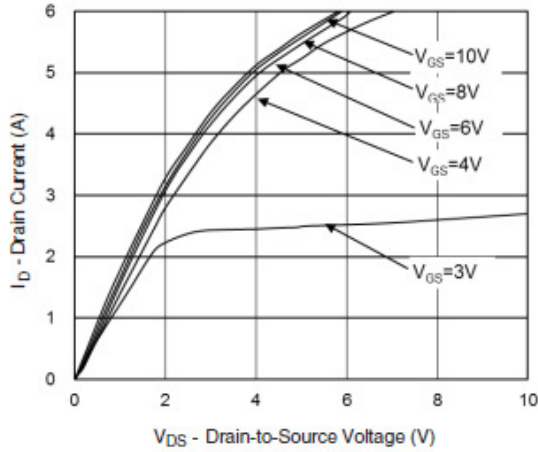

Output Characteristics

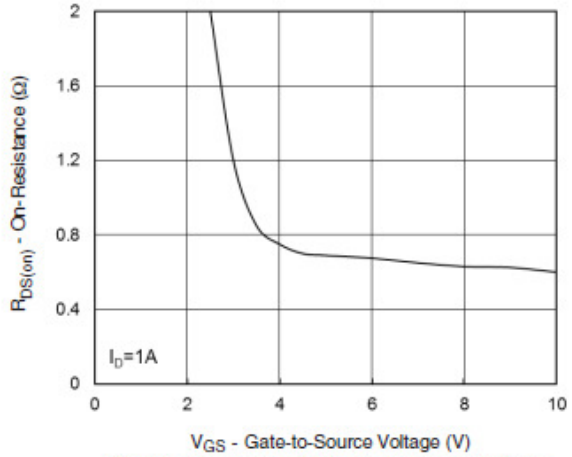

On-Resistance vs. Gate-to-Source Voltage

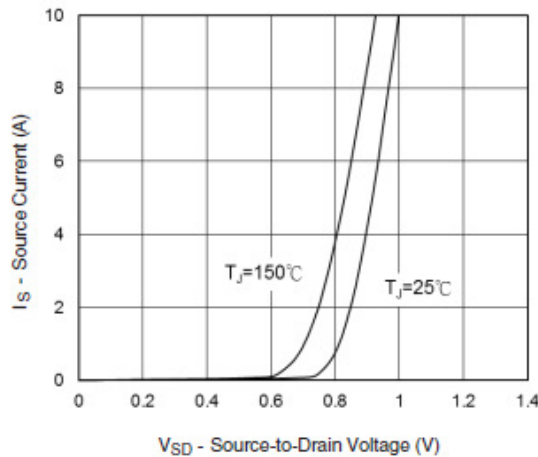

Source-Drain Diode Forward Voltage

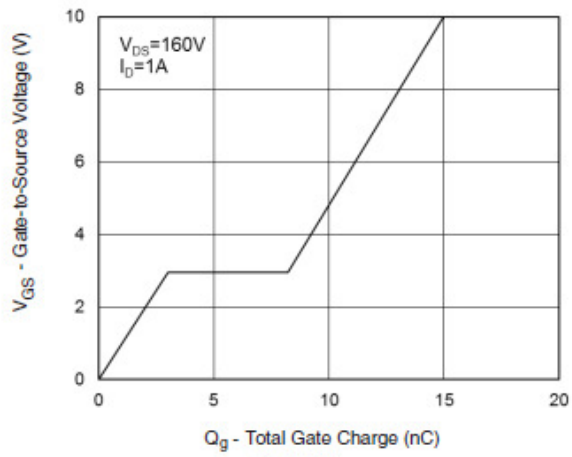

Gate Charge

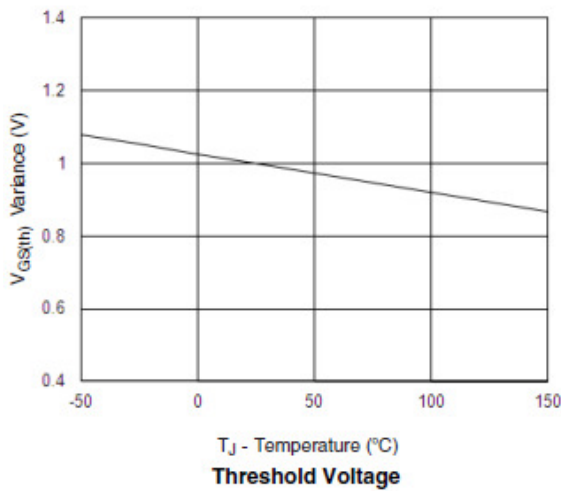

Threshold Voltage

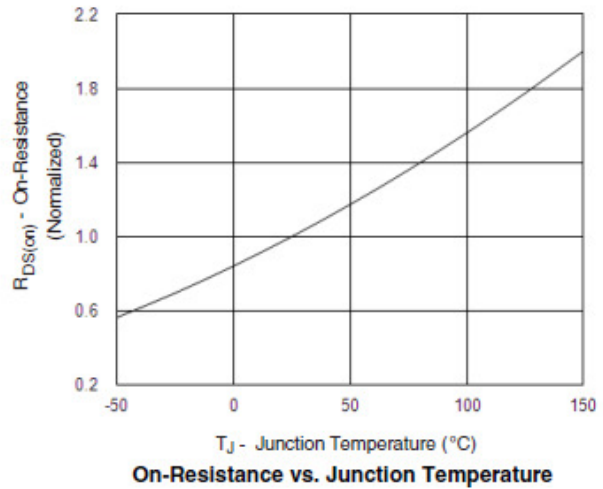

On-Resistance vs. Junction Temperature



## Typical Characteristics

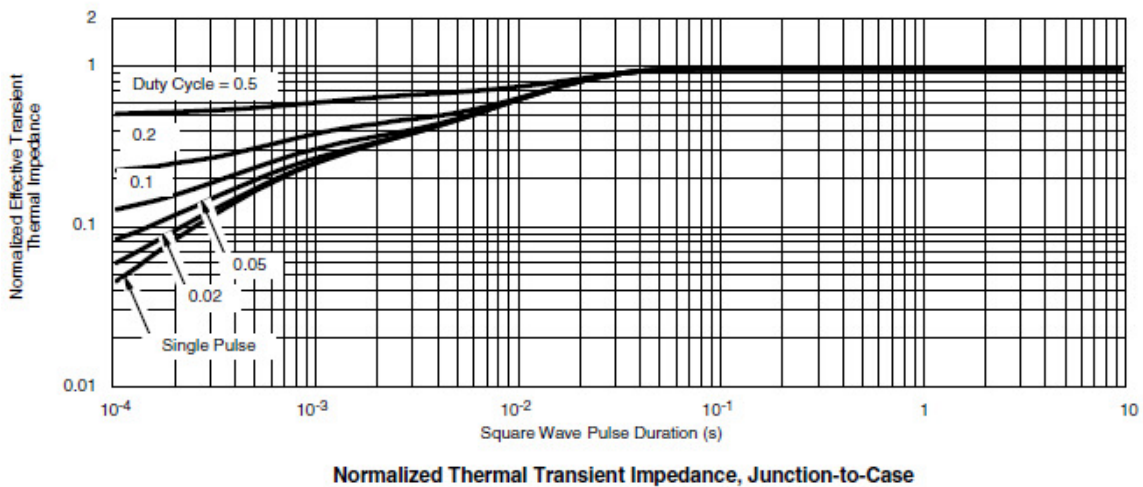
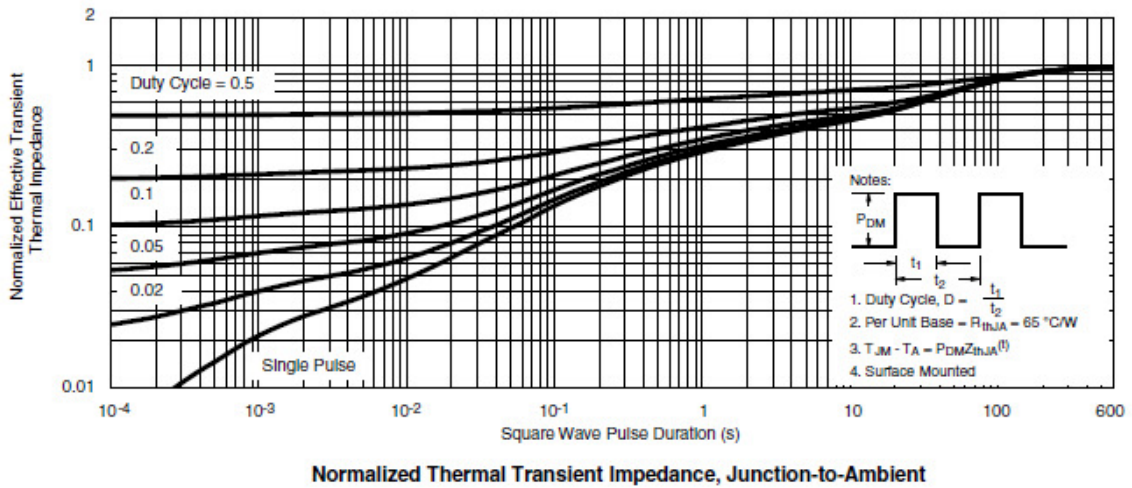
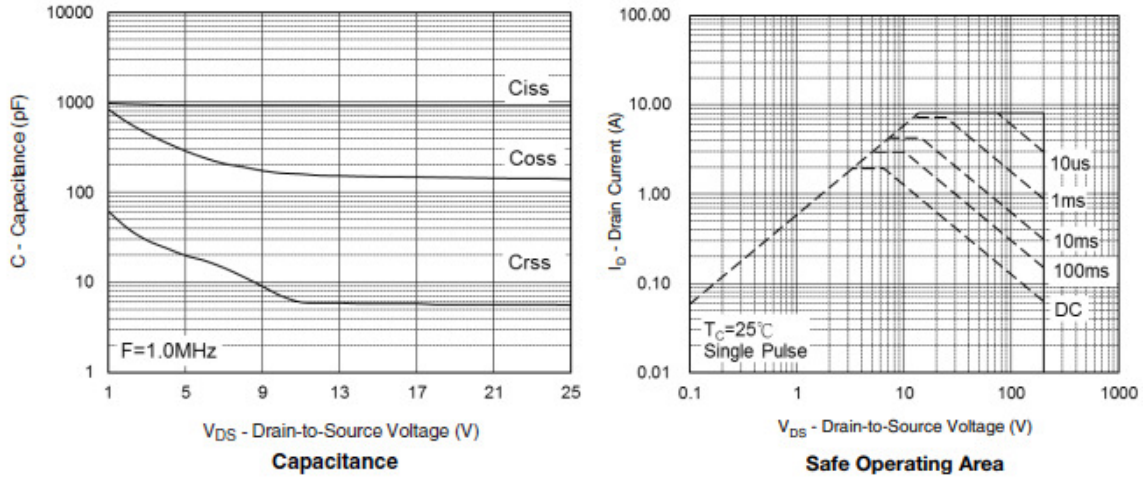



**Typical Characteristics**

Gate Charge Test Circuit & Waveform

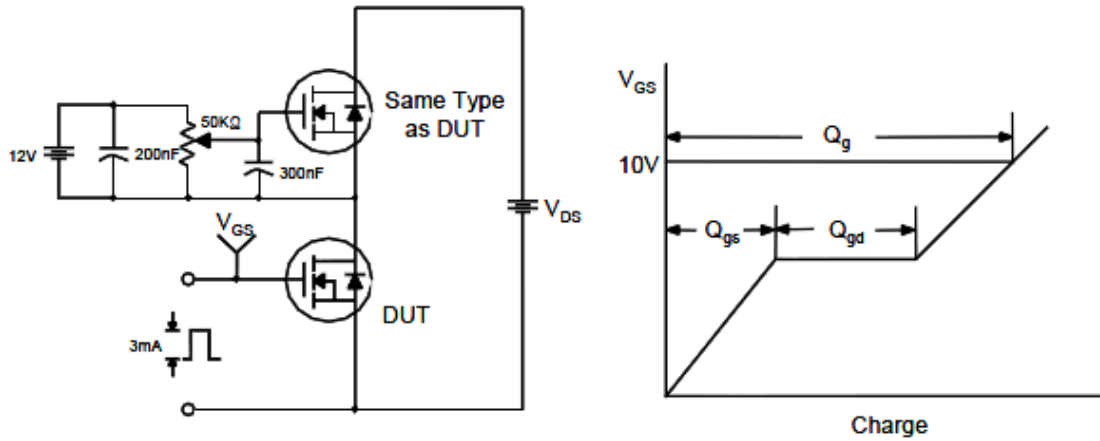

Resistive Switching Test Circuit & Waveforms

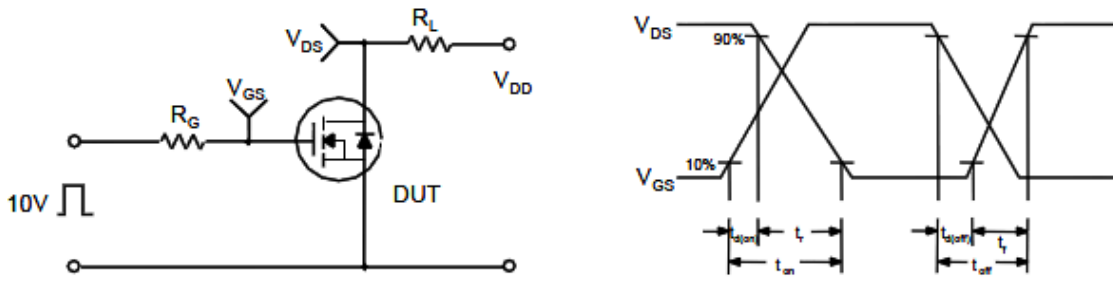

Unclamped Inductive Switching Test Circuit & Waveforms

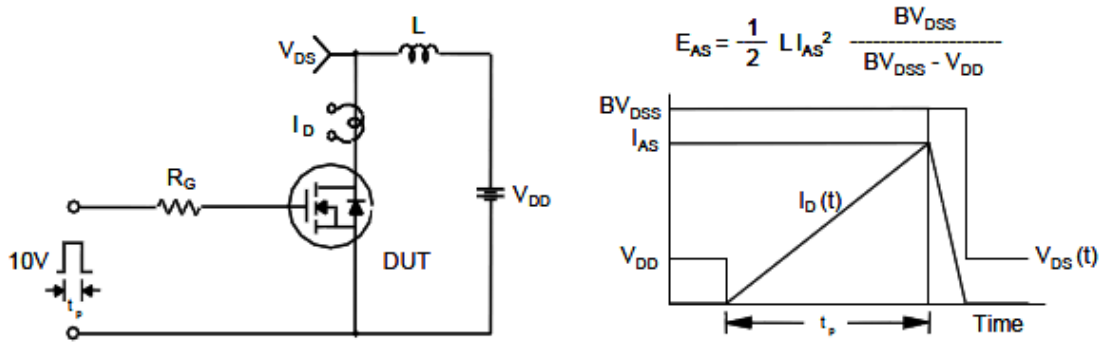



**Package Information ( SOT-23-6L )**

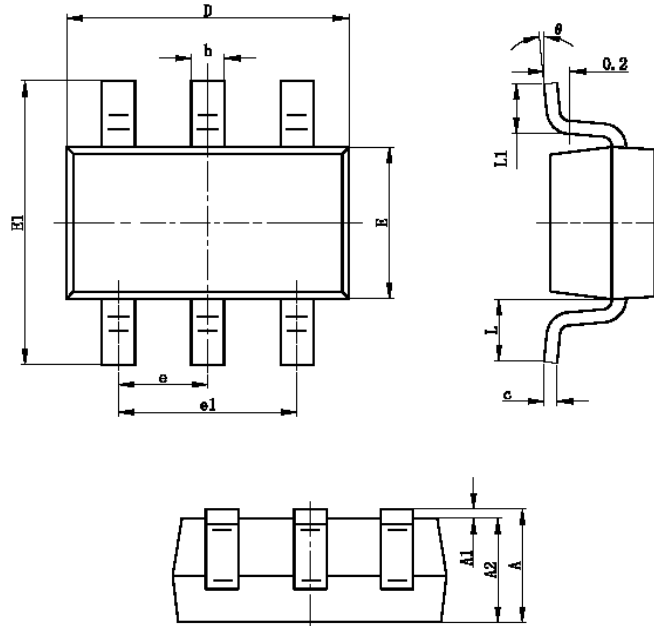

Symbol	Dimensions In Millimeters		Dimensions In Inches	
	Min	Max	Min	Max
A	1.050	1.250	0.041	0.049
A1	0.000	0.100	0.000	0.004
A2	1.050	1.150	0.041	0.045
b	0.300	0.400	0.012	0.016
c	0.100	0.200	0.004	0.008
D	2.820	3.020	0.111	0.119
E	1.500	1.700	0.059	0.067
E1	2.650	2.950	0.104	0.116
e	0.950TYP		0.037TYP	
e1	1.800	2.000	0.071	0.079
L	0.700REF		0.028REF	
L1	0.300	0.600	0.012	0.024
θ	0°	8°	0°	8°

©2010 Alfa-MOS Technology Corp.  
 2F, No.80, Sec.1, Cheng Kung Rd., Nan Kang Dist., Taipei City 115, Taiwan (R.O.C.)  
 Tel : 886 2) 2651 3928  
 Fax : 886 2) 2786 8483  
 ©http://www.alfa-mos.com