



General Description

AFP1013E, P-Channel enhancement mode MOSFET, uses Advanced Trench Technology to provide excellent $R_{DS(ON)}$, low gate charge. These devices are particularly suited for low voltage power management, such as smart phone and notebook computer, and low in-line power loss are needed in commercial industrial surface mount applications.

Features

- -20V/-0.6A, $R_{DS(ON)} = 800 \text{ m}\Omega @ V_{GS} = -4.5\text{V}$
- -20V/-0.5A, $R_{DS(ON)} = 950 \text{ m}\Omega @ V_{GS} = -2.5\text{V}$
- -20V/-0.4A, $R_{DS(ON)} = 1250 \text{ m}\Omega @ V_{GS} = -1.8\text{V}$
- Low Offset (Error) Voltage
- Low-Voltage Operation
- High-Speed Circuits
- ESD Protection Diode design-in
- Low Battery Voltage Operation
- SOT-523 package design

Pin Description (SOT-523)

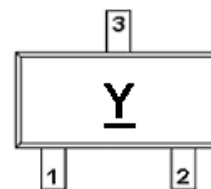
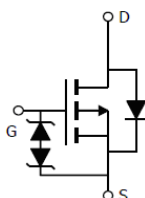
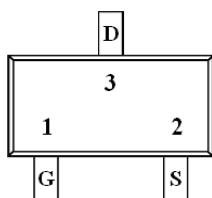

Application

- Drivers: Relays, Solenoids, Lamps, Hammers, Displays, Memories
- Battery Operated Systems
- Power Supply Converter Circuits
- Load/Power Switching Smart Phones, Pagers

Pin Define

Pin	Symbol	Description
1	G	Gate
2	S	Source
3	D	Drain

Ordering Information

Part Ordering No.	Part Marking	Package	Unit	Quantity
AFP1013ES52RG	Y	SOT-523	Tape & Reel	3000 EA

※ AFP1013ES52RG : 7" Tape & Reel ; Pb- Free ; Halogen -Free



Absolute Maximum Ratings

($T_A=25^\circ\text{C}$ Unless otherwise noted)

Parameter	Symbol	Value	Unit
Drain-Source Voltage	V_{DSS}	-20	V
Gate-Source Voltage	V_{GSS}	± 12	V
Continuous Drain Current($T_J=150^\circ\text{C}$)	I_D	$T_A=25^\circ\text{C}$	-0.7
		$T_A=70^\circ\text{C}$	-0.4
Pulsed Drain Current	I_{DM}	-1.0	A
Continuous Source Current(Diode Conduction)	I_S	-0.3	A
Power Dissipation	P_D	$T_A=25^\circ\text{C}$	0.27
		$T_A=70^\circ\text{C}$	0.16
Operating Junction Temperature	T_J	-55/150	$^\circ\text{C}$
Storage Temperature Range	T_{STG}	-55/150	$^\circ\text{C}$

Electrical Characteristics

($T_A=25^\circ\text{C}$ Unless otherwise noted)

Parameter	Symbol	Conditions	Min.	Typ	Max.	Unit
Static						
Drain-Source Breakdown Voltage	$V_{(BR)DSS}$	$V_{GS}=0V, I_D=-250\mu\text{A}$	-20			V
Gate Threshold Voltage	$V_{GS(th)}$	$V_{DS}=V_{GS}, I_D=-250\mu\text{A}$	-0.4		-1.0	
Gate Leakage Current	I_{GSS}	$V_{DS}=0V, V_{GS}=\pm 12V$			± 1	mA
Zero Gate Voltage Drain Current	I_{DSS}	$V_{DS}=-20V, V_{GS}=0V$			-5	uA
		$V_{DS}=-20V, V_{GS}=0V$ $T_J=85^\circ\text{C}$			-10	
On-State Drain Current	$I_{D(on)}$	$V_{DS} \geq 5V, V_{GS}=4.5V$	0.7			A
Drain-Source On-Resistance	$R_{DS(on)}$	$V_{GS}=-4.5V, I_D=-0.6A$		550	800	m Ω
		$V_{GS}=-2.5V, I_D=-0.5A$		700	950	
		$V_{GS}=-1.8V, I_D=-0.4A$		1000	1250	
Forward Transconductance	g_{FS}	$V_{DS}=-10V, I_D=-0.4A$		1		S
Diode Forward Voltage	V_{SD}	$I_S=-0.15A, V_{GS}=0V$		0.65	1.2	V
Dynamic						
Input Capacitance	C_{iss}	$V_{DS}=-10V, V_{GS}=0V$ $f=1\text{MHz}$		70	100	pF
Output Capacitance	C_{oss}			20		
Reverse Transfer Capacitance	C_{rss}			10		
Total Gate Charge	Q_g	$V_{DS}=-10V, V_{GS}=-4.5V$ $I_D \equiv -0.25A$		1.0	1.3	nC
Gate-Source Charge	Q_{gs}			0.1		
Gate-Drain Charge	Q_{gd}			0.3		
Turn-On Time	$t_{d(on)}$	$V_{DD}=-10V, R_L=30\Omega$ $I_D \equiv -0.2A, V_{GEN}=-4.5V$ $R_G=10\Omega$		10	15	ns
	t_r			10	15	
Turn-Off Time	$t_{d(off)}$			40	60	
	t_f			30	50	



Typical Characteristics

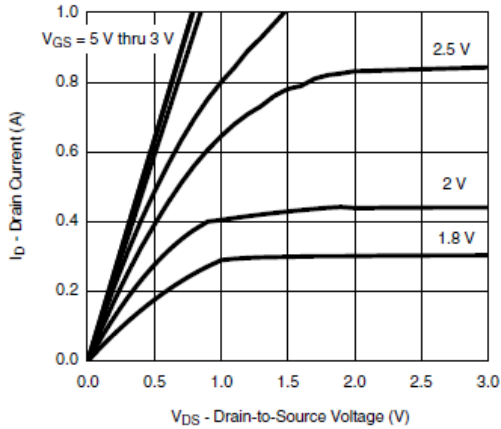

Output Characteristics

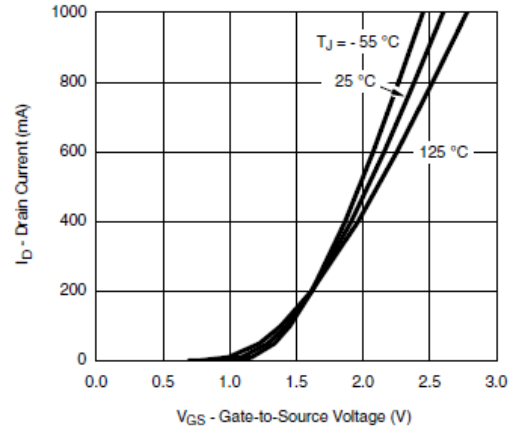

Transfer Characteristics

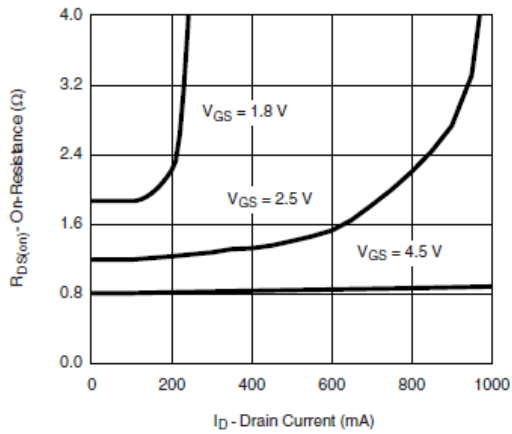

On-Resistance vs. Drain Current

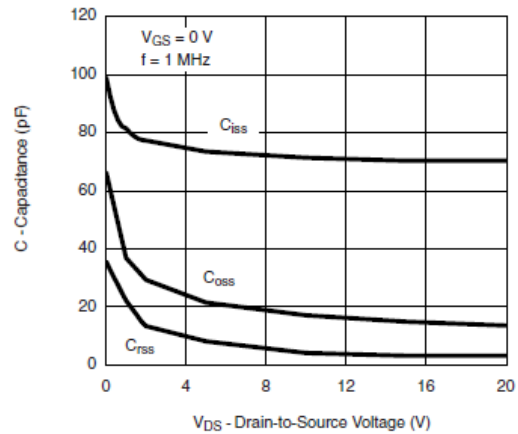

Capacitance

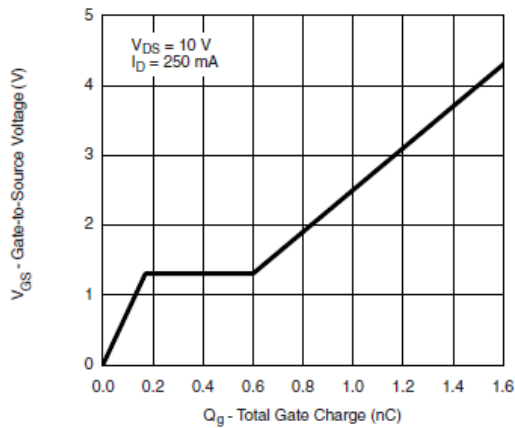

Gate Charge

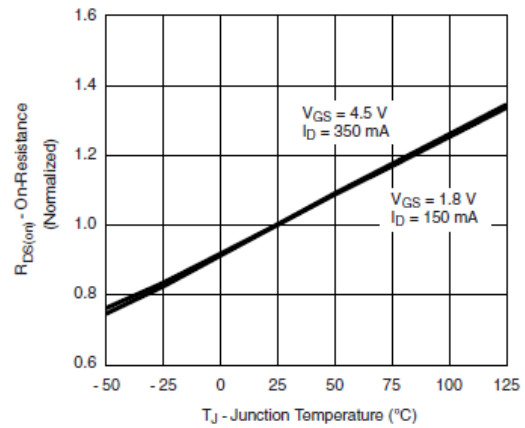

On-Resistance vs. Junction Temperature



Typical Characteristics

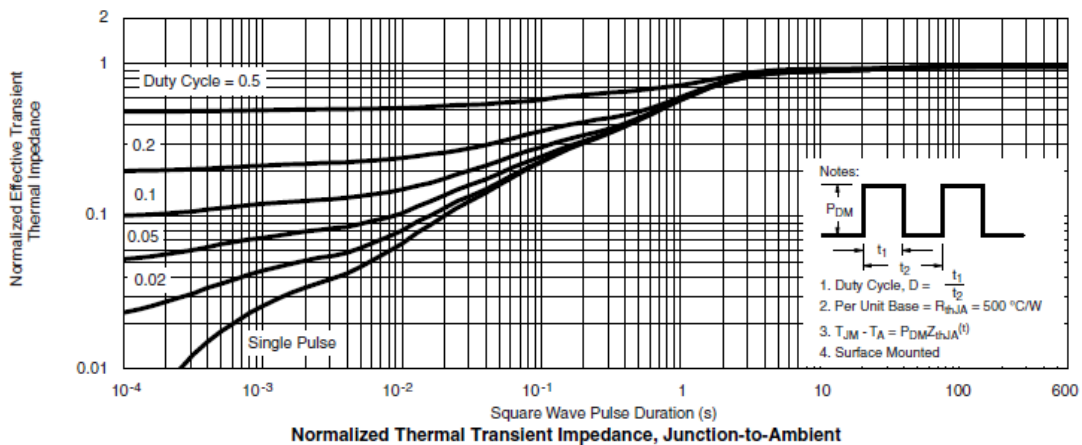
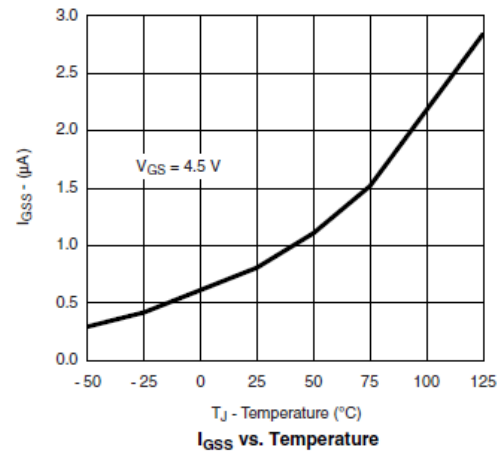
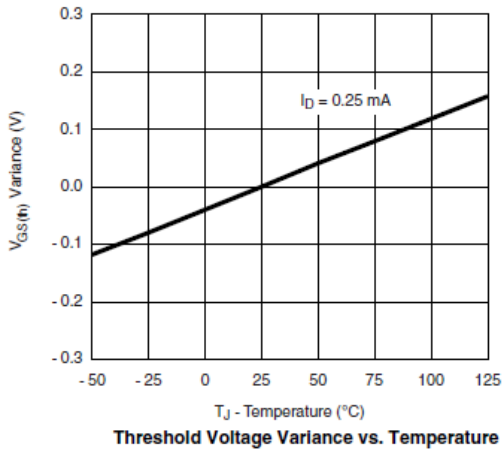
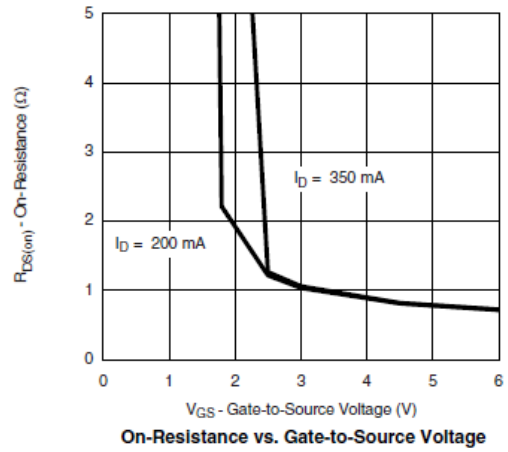
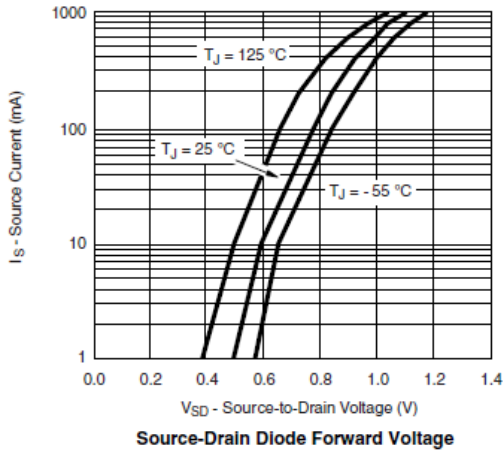



Typical Characteristics

Gate Charge Test Circuit & Waveform

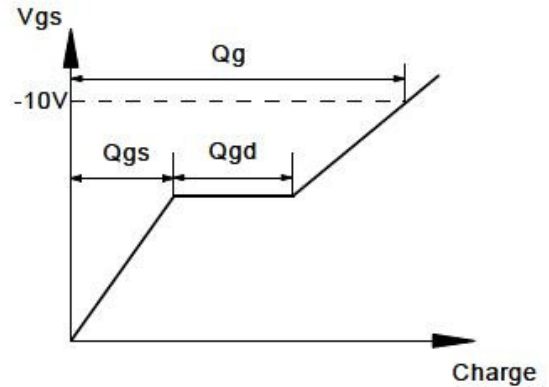
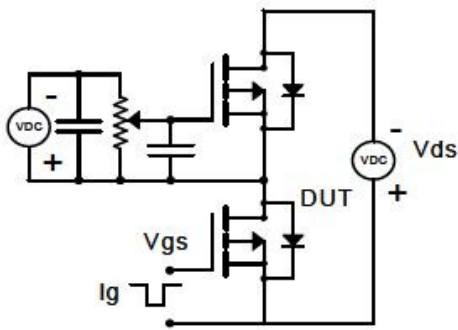

Resistive Switching Test Circuit & Waveforms

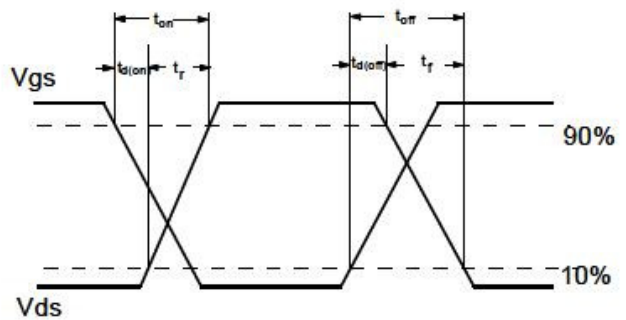
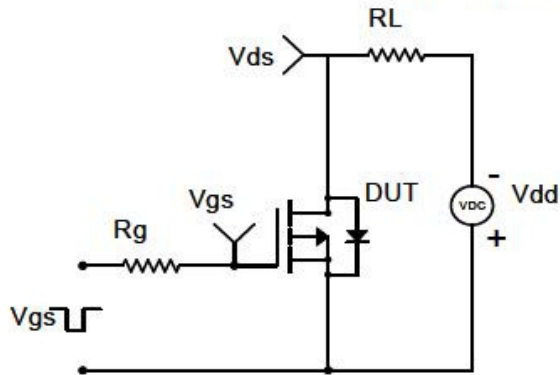

Diode Recovery Test Circuit & Waveforms

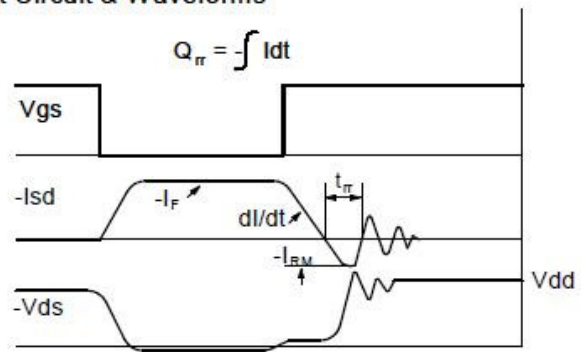
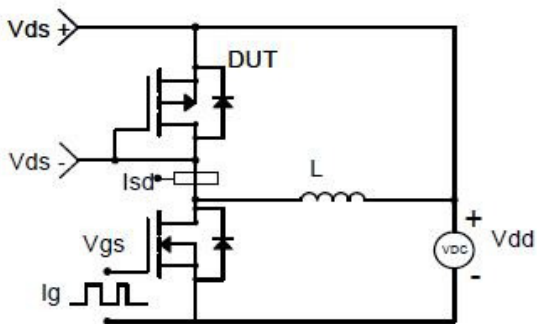



Package Information (SOT-523)

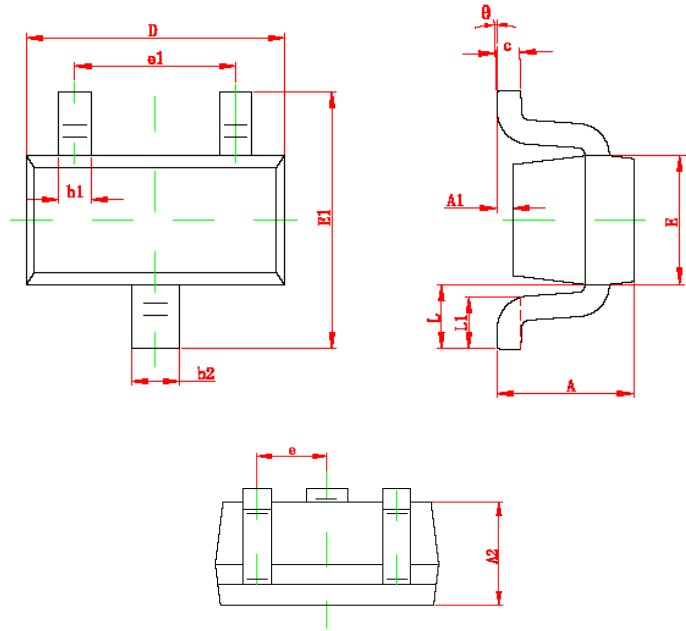

Symbol	Dimensions In Millimeters		Dimensions In Inches	
	Min	Max	Min	Max
A	0.700	0.900	0.028	0.035
A1	0.000	0.100	0.000	0.004
A2	0.700	0.800	0.028	0.031
b1	0.150	0.250	0.006	0.010
b2	0.250	0.325	0.010	0.013
c	0.100	0.200	0.004	0.008
D	1.500	1.700	0.059	0.067
E	0.750	0.850	0.030	0.033
E1	1.450	1.750	0.057	0.069
e	0.500 TYP		0.020 TYP	
e1	0.900	1.100	0.035	0.043
L	0.550 REF		0.022 REF	
L1	0.280	0.440	0.011	0.017
θ	0°	4°	0°	4°

©2010 Alfa-MOS Technology Corp.
 2F, No.80, Sec.1, Cheng Kung Rd., Nan Kang Dist., Taipei City 115, Taiwan (R.O.C.)
 Tel : 886 2) 2651 3928
 Fax : 886 2) 2786 8483
 ©http://www.alfa-mos.com