



General Description

AFP2323A, P-Channel enhancement mode MOSFET, uses Advanced Trench Technology to provide excellent $R_{DS(ON)}$, low gate charge. These devices are particularly suited for low voltage power management, and low in-line power loss are needed in commercial industrial surface mount applications.

Features

- -30V/-2.8A, $R_{DS(ON)}=155m\Omega@V_{GS}=-10.0V$
- -30V/-2.4A, $R_{DS(ON)}=240m\Omega@V_{GS}=-4.5V$
- Super high density cell design for extremely low $R_{DS(ON)}$
- Exceptional on-resistance and maximum DC current capability
- SOT-23 package design

Pin Description (SOT-23)

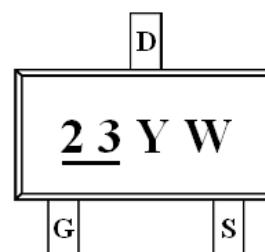
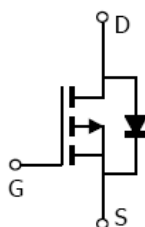
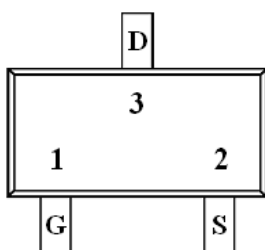

Application

- Battery Switch for Portable Devices
- Computers
 - Bus Switch
 - Load Switch LED Display

Pin Define

Pin	Symbol	Description
1	G	Gate
2	S	Source
3	D	Drain

Ordering Information

Part Ordering No.	Part Marking	Package	Unit	Quantity
AFP2323AS23RG	23YW	SOT-23	Tape & Reel	3000 EA

- ※ 23 parts code
- ※ Y year code (0 ~ 9)
- ※ W week code (A ~ Z = 1 ~ 26 / a ~ z = 27 ~ 52)
- ※ AFP2323AS23RG : 7" Tape & Reel ; Pb- Free ; Halogen -Free



Absolute Maximum Ratings

($T_A=25^\circ\text{C}$ Unless otherwise noted)

Parameter	Symbol	Value	Unit
Drain-Source Voltage	V_{DSS}	-30	V
Gate-Source Voltage	V_{GSS}	± 20	V
Continuous Drain Current($T_J=150^\circ\text{C}$)	I_D	$T_A=25^\circ\text{C}$	-3.6
		$T_A=70^\circ\text{C}$	-2.4
Pulsed Drain Current	I_{DM}	-15	A
Continuous Source Current(Diode Conduction)	I_S	-1.5	A
Power Dissipation	P_D	$T_A=25^\circ\text{C}$	1.25
		$T_A=70^\circ\text{C}$	0.8
Operating Junction Temperature	T_J	150	$^\circ\text{C}$
Storage Temperature Range	T_{STG}	-55/150	$^\circ\text{C}$
Thermal Resistance-Junction to Ambient	$R_{\theta JA}$	120	$^\circ\text{C/W}$

Electrical Characteristics

($T_A=25^\circ\text{C}$ Unless otherwise noted)

Parameter	Symbol	Conditions	Min.	Typ	Max.	Unit
Static						
Drain-Source Breakdown Voltage	$V_{(BR)DSS}$	$V_{GS}=0V, I_D=-250\mu\text{A}$	-30			V
Gate Threshold Voltage	$V_{GS(th)}$	$V_{DS}=V_{GS}, I_D=-250\mu\text{A}$	-1.0		-2.6	V
Gate Leakage Current	I_{GSS}	$V_{DS}=0V, V_{GS}=\pm 20V$			± 100	nA
Zero Gate Voltage Drain Current	I_{DSS}	$V_{DS}=-24V, V_{GS}=0V$			-1	μA
		$V_{DS}=-24V, V_{GS}=0V$ $T_A=85^\circ\text{C}$			-30	
On-State Drain Current	$I_{D(on)}$	$V_{DS} \leq -5V, V_{GS}=-10V$	-10			A
Drain-Source On-Resistance	$R_{DS(on)}$	$V_{GS}=-10.0V, I_D=-2.8A$		140	155	m Ω
		$V_{GS}=-4.5V, I_D=-2.4A$		220	240	
Forward Transconductance	g_{FS}	$V_{DS}=-5V, I_D=-4.0A$		10		S
Diode Forward Voltage	V_{SD}	$I_S=-1.5A, V_{GS}=0V$		-0.7	-1.3	V
Dynamic						
Total Gate Charge	Q_g	$V_{DS}=-15V, V_{GS}=-4.5V$ $I_D \equiv -2.5A$		2.5		nC
Gate-Source Charge	Q_{gs}			0.8		
Gate-Drain Charge	Q_{gd}			1.0		
Input Capacitance	C_{iss}	$V_{DS}=-15V, V_{GS}=0V$ $f=1\text{MHz}$		170		pF
Output Capacitance	C_{oss}			50		
Reverse Transfer Capacitance	C_{rss}			30		
Turn-On Time	$t_{d(on)}$	$V_{DD}=-15V, R_L=7.5\Omega$ $I_D \equiv -2.0A, V_{GEN}=-10V$ $R_G=1\Omega$		5	10	ns
	t_r			10	16	
Turn-Off Time	$t_{d(off)}$			10	16	
	t_f			5	10	



Typical Characteristics

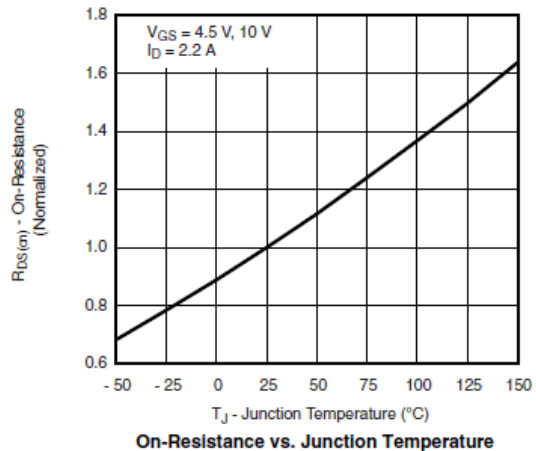
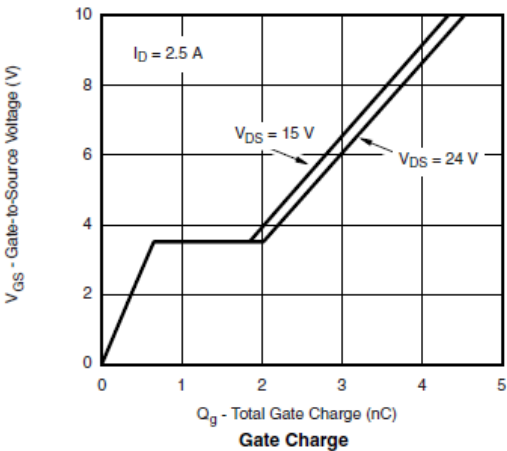
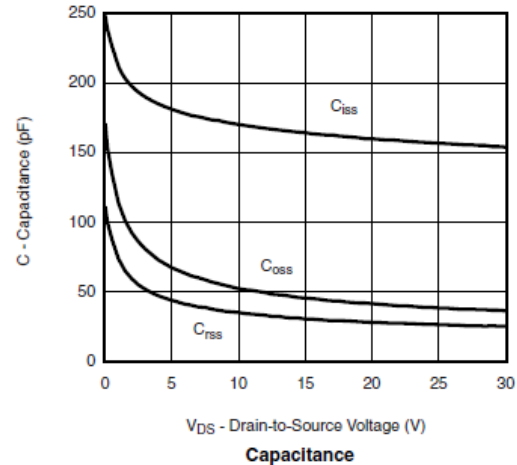
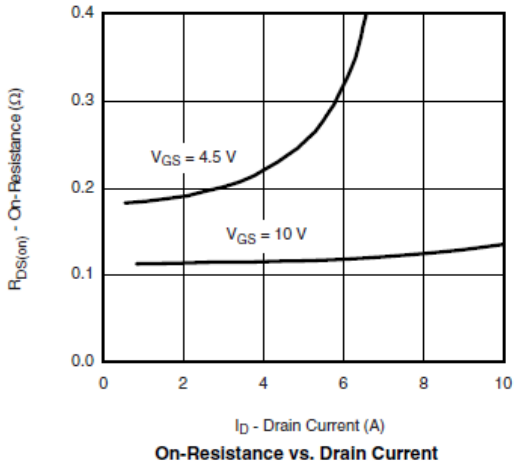
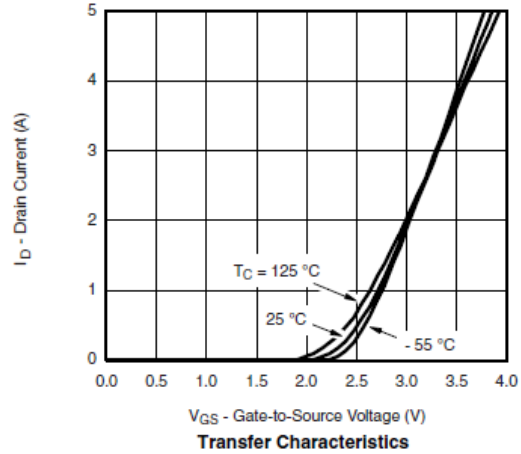
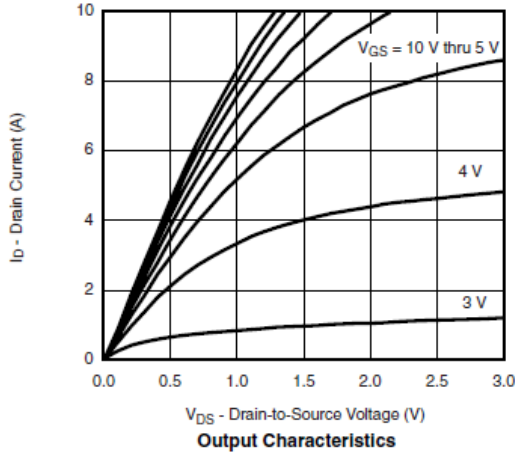



Typical Characteristics

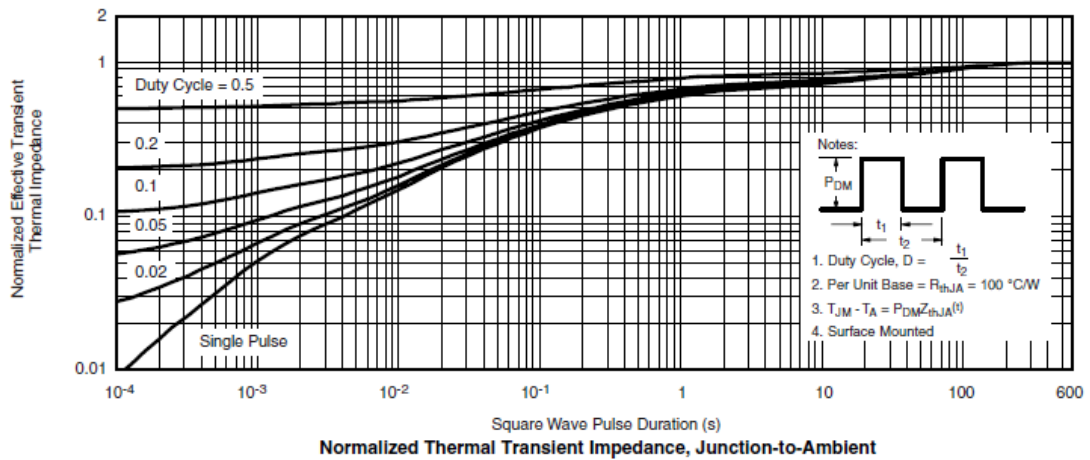
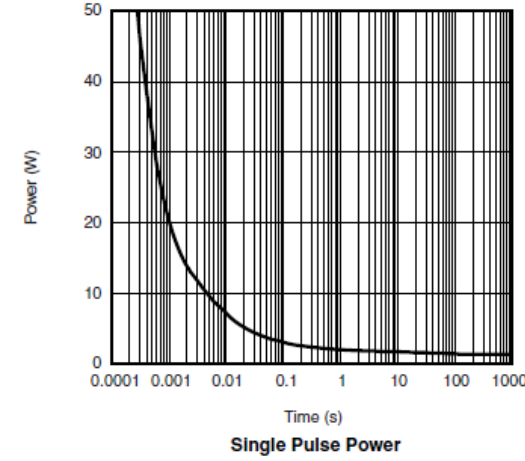
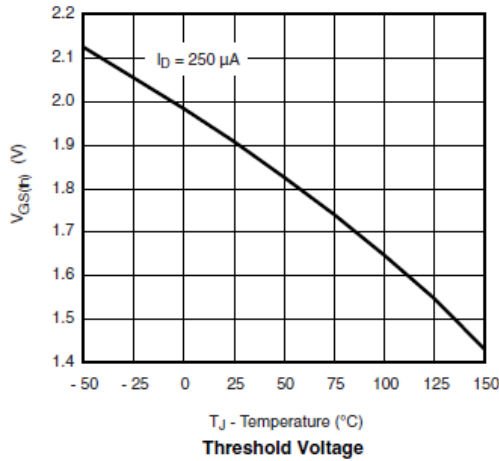
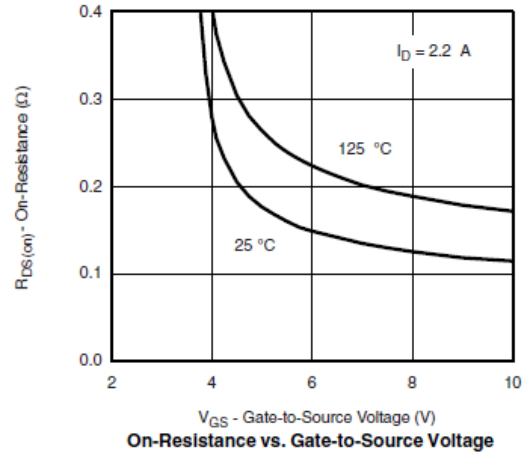
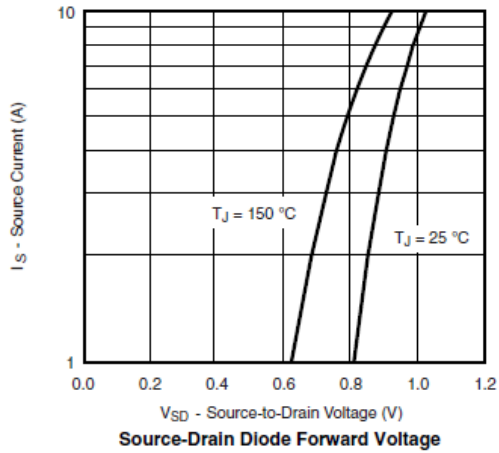



Typical Characteristics

Gate Charge Test Circuit & Waveform



Resistive Switching Test Circuit & Waveforms

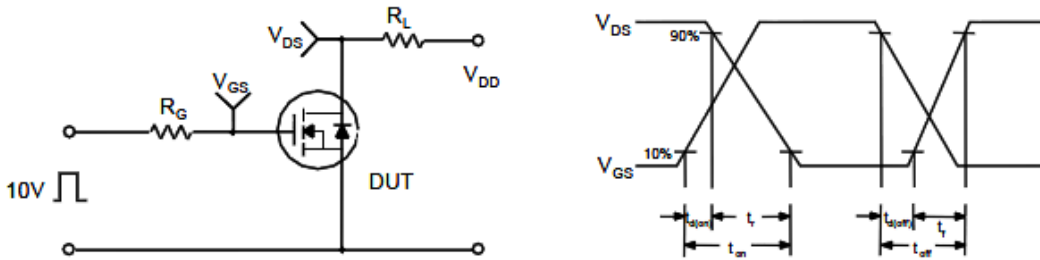

Unclamped Inductive Switching Test Circuit & Waveforms

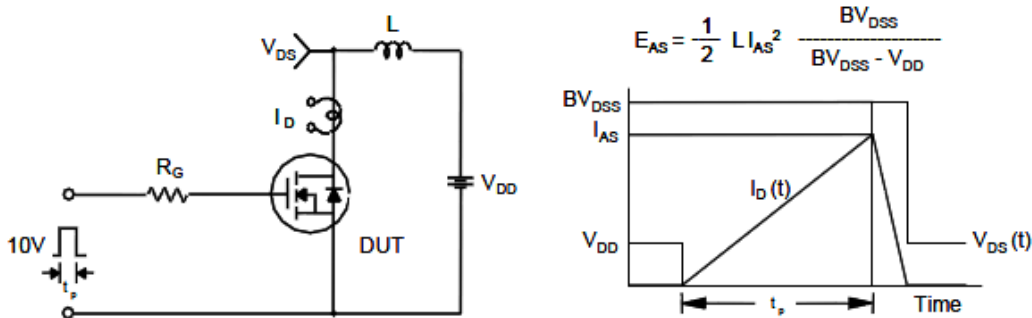



Package Information (SOT-23)

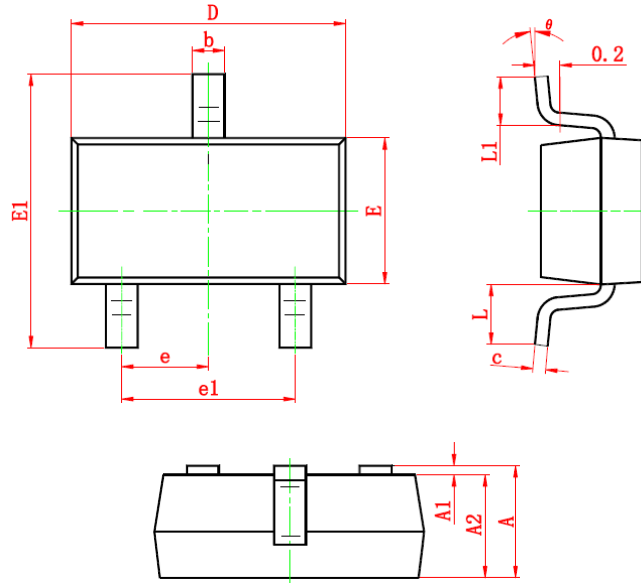

Symbol	Dimensions In Millimeters		Dimensions In Inches	
	Min	Max	Min	Max
A	0.900	1.200	0.035	0.043
A1	0.000	0.100	0.000	0.004
A2	0.900	1.100	0.035	0.039
b	0.300	0.500	0.012	0.020
c	0.080	0.150	0.003	0.006
D	2.800	3.000	0.110	0.118
E	1.200	1.400	0.047	0.055
E1	2.250	2.550	0.089	0.100
e	0.950 TYP		0.037 TYP	
e1	1.800	2.000	0.071	0.079
L	0.550 REF		0.022 REF	
L1	0.300	0.500	0.012	0.020
theta	0°	8°	0°	6°

©2010 Alfa-MOS Technology Corp.
2F, No.80, Sec.1, Cheng Kung Rd., Nan Kang Dist., Taipei City 115, Taiwan (R.O.C.)
Tel : 886 2) 2651 3928
Fax : 886 2) 2786 8483
©http://www.alfa-mos.com