



General Description

AFP8943, P-Channel enhancement mode MOSFET, uses Advanced Trench Technology to provide excellent $R_{DS(ON)}$, low gate charge. These devices are particularly suited for low voltage power management, and low in-line power loss are needed in commercial industrial surface mount applications.

Features

- -40V/-4.6A, $R_{DS(ON)} = 43m\Omega @ V_{GS} = -10V$
- -40V/-3.6A, $R_{DS(ON)} = 58m\Omega @ V_{GS} = -4.5V$
- Super high density cell design for extremely low $R_{DS(ON)}$
- SOT-89-3L package design

Pin Description (SOT-89-3L)

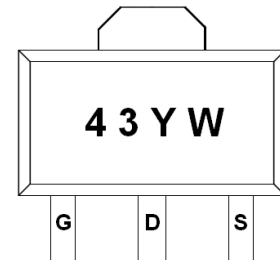
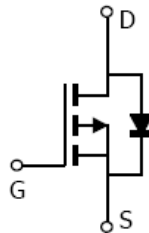
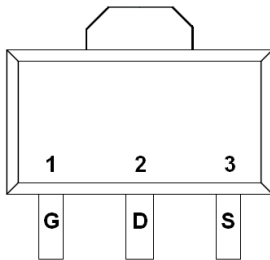

Application

- Motor and Load Control
- LCD TV Inverter & AD/DC Inverter Systems.
- Backlight Inverter for LCD Display
- Load Switch
- CCFL Inverter

Pin Define

Pin	Symbol	Description
1	G	Gate
2	D	Drain
3	S	Source

Ordering Information

Part Ordering No.	Part Marking	Package	Unit	Quantity
AFP8943S89RG	43YW	SOT-89-3L	Tape & Reel	1000 EA

- ※ 43 parts code
- ※ Y year code (0 ~ 9)
- ※ W week code (A ~ Z = 1 ~ 26 / a ~ z = 27 ~ 52)
- ※ AFP8943S89RG : 7" Tape & Reel ; Pb- Free ; Halogen -Free



Absolute Maximum Ratings

($T_A=25^\circ\text{C}$ Unless otherwise noted)

Parameter	Symbol	Value	Unit
Drain-Source Voltage	V_{DS}	-40	V
Gate-Source Voltage	V_{GS}	± 20	V
Continuous Drain Current($T_J=150^\circ\text{C}$)	I_D	$T_A=25^\circ\text{C}$	-4.6
		$T_A=70^\circ\text{C}$	-3.6
Pulsed Drain Current	I_{DM}	-10	A
Continuous Source Current(Diode Conduction)	I_S	-1.6	A
Power Dissipation	P_D	$T_A=25^\circ\text{C}$	1.45
		$T_A=70^\circ\text{C}$	0.6
Operating Junction Temperature	T_J	150	$^\circ\text{C}$
Storage Temperature Range	T_{STG}	-55/150	$^\circ\text{C}$
Thermal Resistance-Junction to Ambient	$R_{\theta JA}$	120	$^\circ\text{C/W}$

Electrical Characteristics

($T_A=25^\circ\text{C}$ Unless otherwise noted)

Parameter	Symbol	Conditions	Min.	Typ	Max.	Unit
Static						
Drain-Source Breakdown Voltage	$V_{(BR)DSS}$	$V_{GS}=0V, I_D = -250\mu\text{A}$	-40			V
Gate Threshold Voltage	$V_{GS(th)}$	$V_{DS}=V_{GS}, I_D = -250\mu\text{A}$	-1.0		-3.0	
Gate Leakage Current	I_{GSS}	$V_{DS}=0V, V_{GS} = \pm 20V$			± 100	nA
Zero Gate Voltage Drain Current	I_{DSS}	$V_{DS} = -40V, V_{GS} = 0V$			-1	uA
		$V_{DS} = -40V, V_{GS} = 0V$ $T_J=85^\circ\text{C}$			-20	
On-State Drain Current	$I_{D(on)}$	$V_{DS} \geq -5V, V_{GS} = -10V$	-20			A
Drain-Source On-Resistance	$R_{DS(on)}$	$V_{GS} = -10V, I_D = -4.6A$		36	43	m Ω
		$V_{GS} = -4.5V, I_D = -3.6A$		48	58	
Forward Transconductance	g_{FS}	$V_{DS} = -15V, I_D = -5A$		20		S
Diode Forward Voltage	V_{SD}	$I_S = -2A, V_{GS} = 0V$		-0.8	-1.2	V
Dynamic						
Total Gate Charge	Q_g	$V_{DS} = -20V, V_{GS} = -4.5V$ $I_D = -3.0A$		13	20	nC
Gate-Source Charge	Q_{gs}		4.5			
Gate-Drain Charge	Q_{gd}		6.5			
Input Capacitance	C_{iss}	$V_{DS} = -20V, V_{GS} = 0V$ $f = 1\text{MHz}$		1100		pF
Output Capacitance	C_{oss}		145			
Reverse Transfer Capacitance	C_{rss}		115			
Turn-On Time	$t_{d(on)}$	$V_{DD} = -20V, R_L = 4\Omega$ $I_D = -3.0A, V_{GEN} = -4.5V$ $R_G = 1\Omega$		40	80	ns
	t_r			55	100	
Turn-Off Time	$t_{d(off)}$			30	60	
	t_f			12	20	



Typical Characteristics

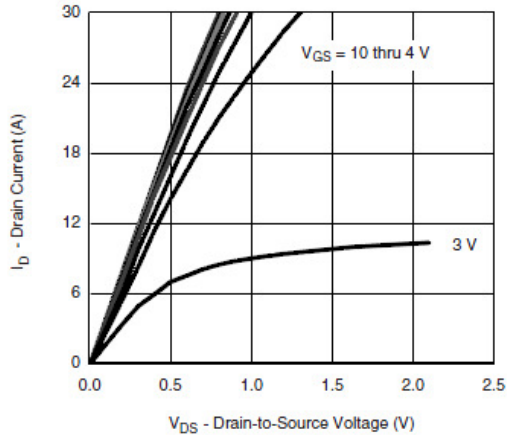

Output Characteristics

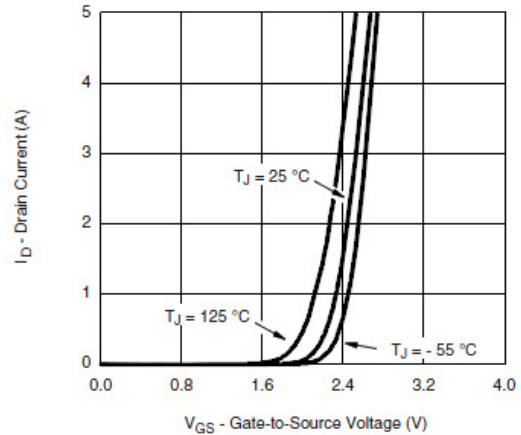

Transfer Characteristics

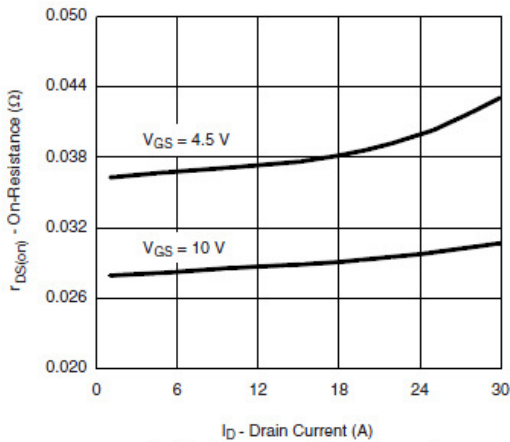

On-Resistance vs. Drain Current

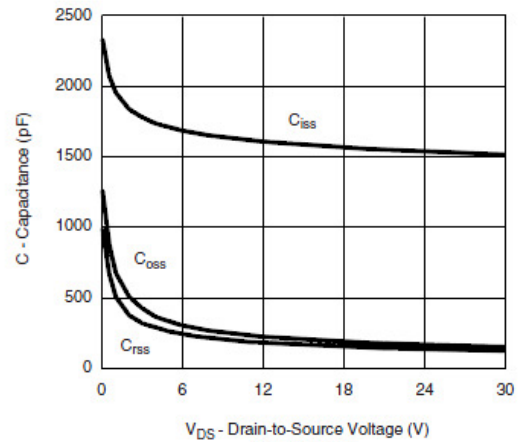

Capacitance

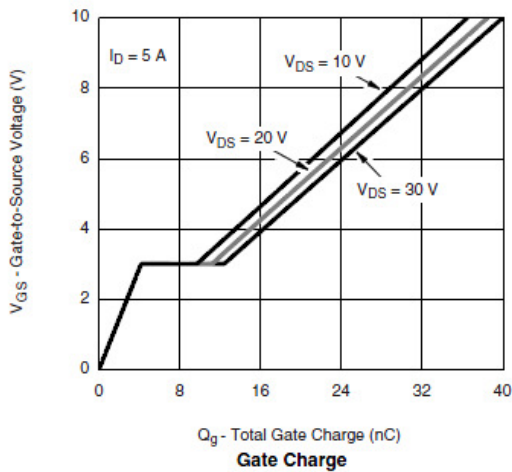

Gate Charge

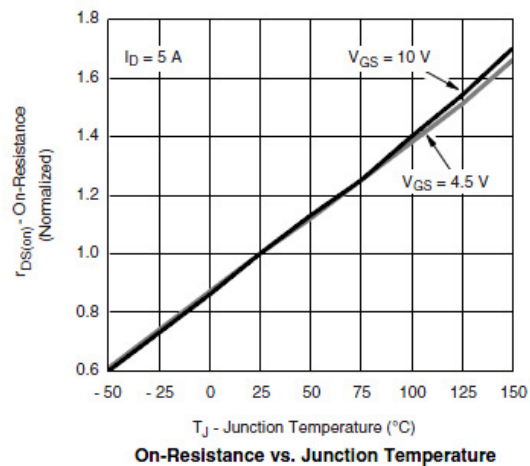

On-Resistance vs. Junction Temperature



Typical Characteristics

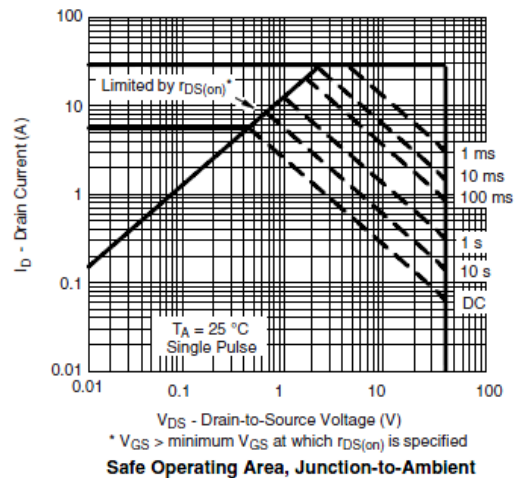
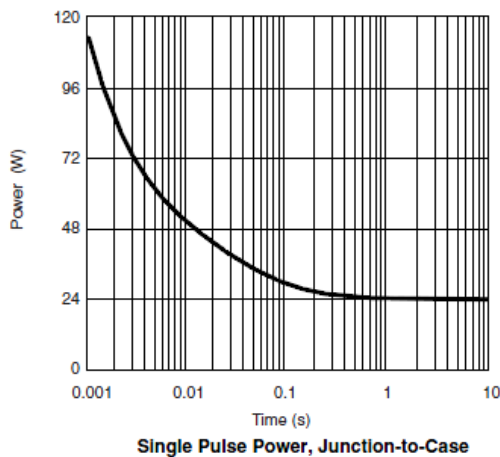
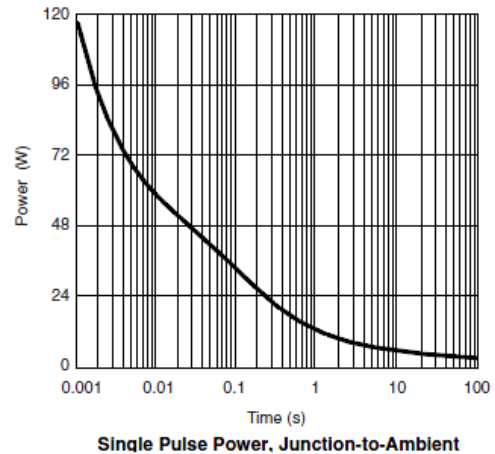
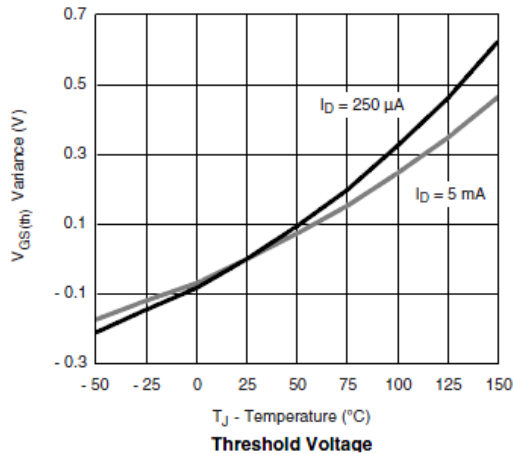
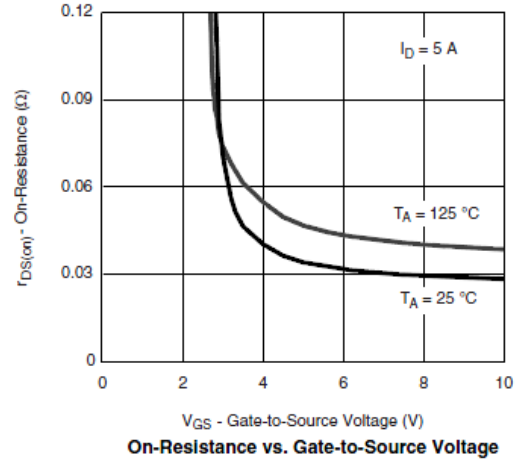
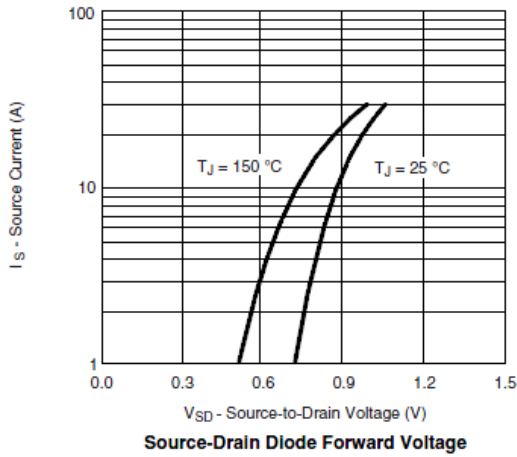



Typical Characteristics

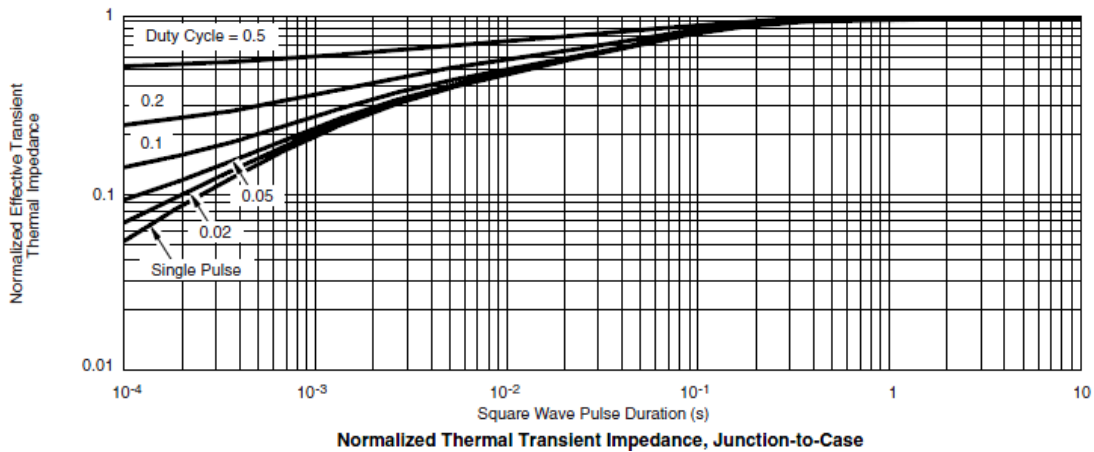
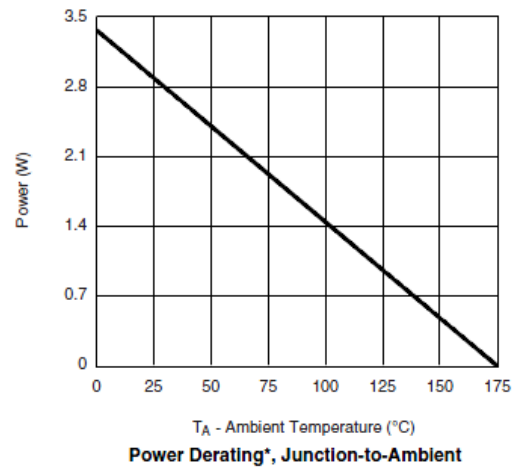
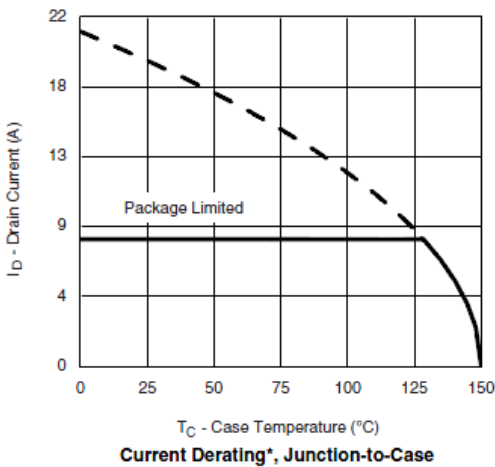
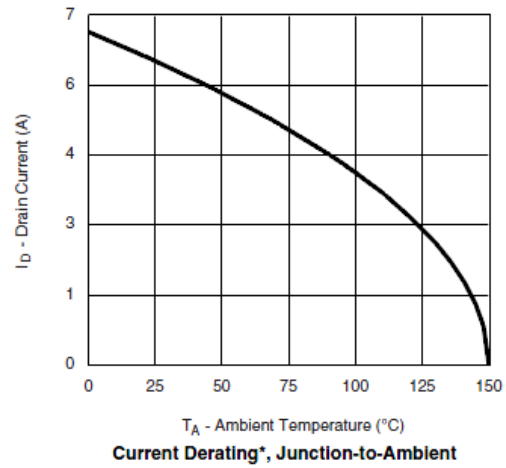
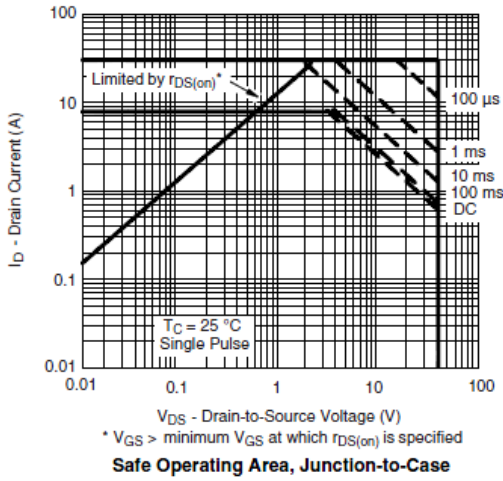



Typical Characteristics

Gate Charge Test Circuit & Waveform

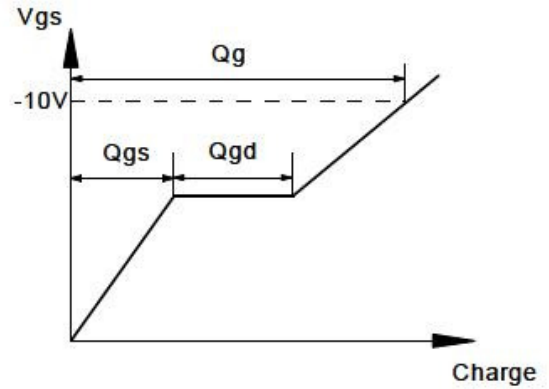
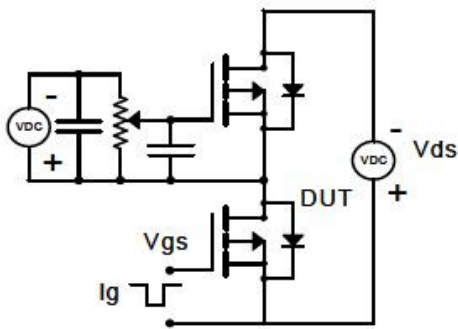

Resistive Switching Test Circuit & Waveforms

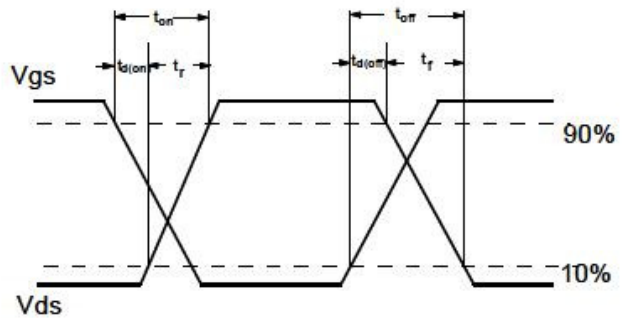
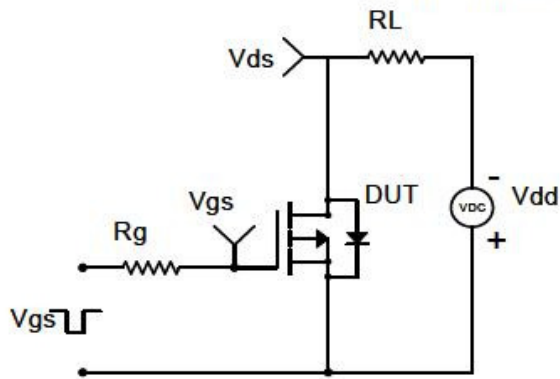

Diode Recovery Test Circuit & Waveforms

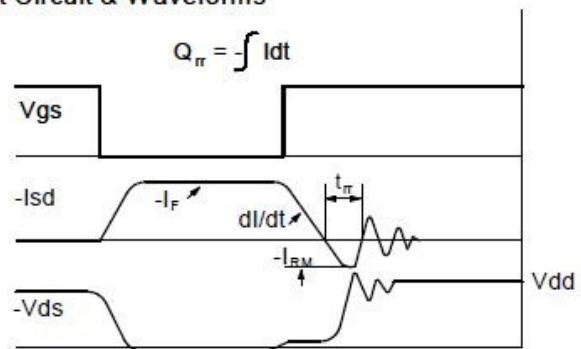
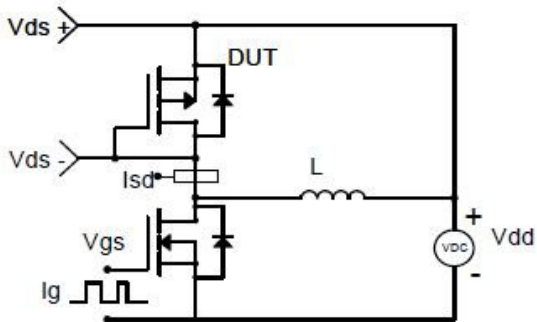



Package Information (SOT-89-3L)

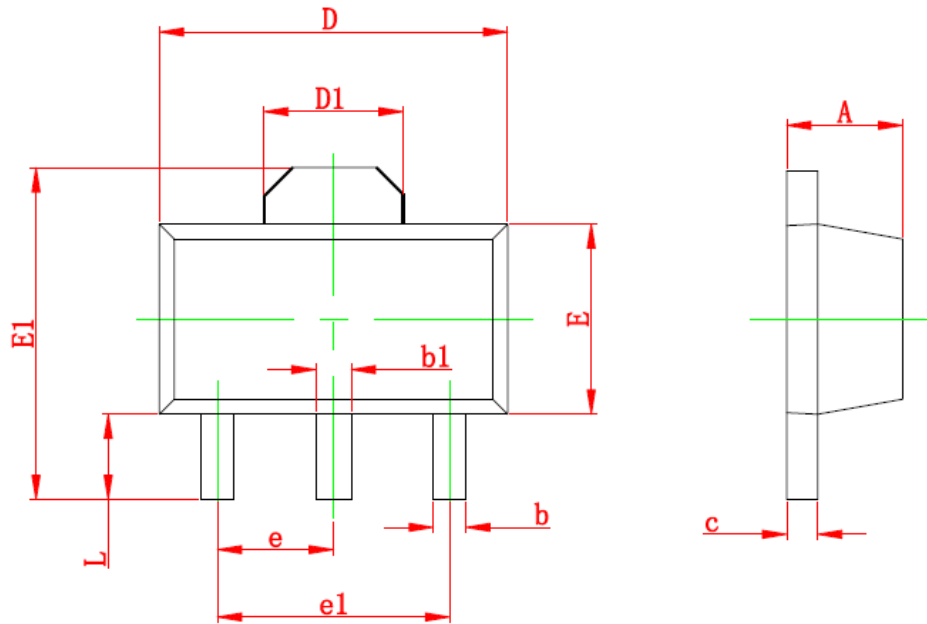

Symbol	Dimensions In Millimeters		Dimensions In Inches	
	Min	Max	Min	Max
A	1.400	1.600	0.055	0.063
b	0.320	0.520	0.013	0.197
b1	0.400	0.580	0.016	0.023
c	0.350	0.440	0.014	0.017
D	4.400	4.600	0.173	0.181
D1	1.550 REF		0.061 REF	
E	2.300	2.600	0.091	0.102
E1	3.940	4.250	0.155	0.167
e	1.500 TYP		0.060TYP	
e1	3.000 TYP		0.118TYP	
L	0.900	1.200	0.035	0.047

©2010 Alfa-MOS Technology Corp.
 2F, No.80, Sec.1, Cheng Kung Rd., Nan Kang Dist., Taipei City 115, Taiwan (R.O.C.)
 Tel : 886 2) 2651 3928
 Fax : 886 2) 2786 8483
 ©http://www.alfa-mos.com